

BESÖKSADRESS

Karlsvägen 10  
828 32 Edsbyn

TELEFON

+46 271 181 13

EPOST

info@edsbypersienner.se

# INTU

Intu är ett utmärkt val för dig som söker en kombination av stil, funktionalitet och enkelhet. Med sin stilrena design och smarta funktioner passar den perfekt in i moderna hem och erbjuder effektiv ljus- och insynskontroll.

2024.04.01

Vi reserverar oss för eventuella tryckfel gällande priser och produkter.

# INNEHÅLL

|                                 |    |                                  |    |
|---------------------------------|----|----------------------------------|----|
| FAKTA _____                     | 03 | DETALJERAD SPECIFIKATION _____   | 35 |
| BARNSÄKERHET _____              | 04 | INTU HONEYCELL _____             | 36 |
| FÄRGKOLLEKTION _____            | 05 | INTU HONEYCELL PRISLISTA _____   | 37 |
| LAMELL, ÖVER- & UNDERLIST _____ | 05 | DETALJERAD SPECIFIKATION _____   | 38 |
| LINA & STEGBAND _____           | 09 | DIMENSIONER _____                | 39 |
| PLISSÉVÄV _____                 | 12 | ÖVERLIST _____                   | 39 |
| HONEYCELLVÄV _____              | 21 | UNDERLIST PERSIENN _____         | 40 |
| PRISLISTOR _____                | 30 | UNDERLIST PLISSÉ/HONEYCELL _____ | 41 |
| INTU PERSIENN _____             | 30 | MANÖVERSET _____                 | 42 |
| INTU PERSIENN PRISLISTA _____   | 31 | GAVEL SET _____                  | 43 |
| DETALJERAD SPECIFIKATION _____  | 32 | NEDRE FÄSTE FÖR LINA _____       | 44 |
| INTU PLISSÉ _____               | 33 | DETALJER _____                   | 45 |
| INTU PLISSÉ PRISLISTA _____     | 34 |                                  |    |



# SOLSKYDD MED STIL OCH FUNKTIONALITET.

Intu är en serie solskyddsprodukter som erbjuder både stil och funktionalitet. Med tre varianter - Persienn, Plissé och Honeycell - finns det en lösning för alla behov.

## PERSIENN

Den klassiska persiennen ger en elegant och modern look till ditt fönster. Den finns i en mängd olika färger och material, och kan anpassas till fönster i alla former och storlekar.

## PLISSÉ

Plissévåven ger en mjuk och behaglig känsla till fönstret. Den finns i en mängd olika färger, material och transparensgrader, och kan anpassas till fönster i alla former och storlekar.

## HONEYCELL

Honeycell väven är en energieffektiv solskyddslösning. Den unika strukturen med luftfickor isolerar ditt hem och kan bidra till energibesparing. Honeycell väven finns i en mängd olika färger och material.

## DUBBELFUNKTION

Intu regleras steglöst utan detaljer. Plissé och Honeycell varianterna kan även fås med dubbelfunktion som ger reglering uppifrån och nedifrån över hela fönstrets yta.





# SMÅ BARN ÄR NYFIKNA AV NATUREN

Allt som hänger löst, rör sig eller går att smaka på måste bara undersökas. Därför kan också solskydd förvandlas till en möjlig fara för nyfikna små barn. Vi prioriterar barnsäkerhet som är en central del i vår designfilosofi. Köpare och användare av solskydd bör vara medvetna om riskerna med löst hängande linor, snoddar samt ögleformade kedjor och linor - de kan utgöra faror för små barn.

## DESSA RIKTLINJER SKA ALLTID FÖLJAS:

- Små barn kan strypas av öglor bildade av draglinor, band och inre snören som används för att manövrera produkten. De kan även råka vira linor runt halsen.
- Flytta sängar, barnsängar och andra möbler bort från solskyddens linor.
- Kontrollera att linorna inte trasslar ihop sig och bildar en ögla.
- Knyt inte ihop linorna.
- För att undvika att barn stryps eller trasslar in sig ska linorna hållas utom räckhåll för små barn.
- Installera och använd säkerhetsanordningar enligt installationsanvisningarna på produkterna för att minska olycksrisken.

# FÄRGKOLLEKTION

## Lamell, över- & underlist

Standardfärg på lamell och list är vit 0065. Utöver den finns ytterligare 26 färger på lamell för olika smaker och sammanhang.

### PRISGRUPP 1

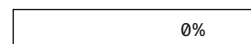

### PRISGRUPP 2

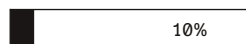

### PRISGRUPP 3



### PRISGRUPP 4



### PRISGRUPP 5



- ✓ Dessa färger finns även i över- och underlist.
- ✗ Dessa färger finns ej som över- och underlist.
- \* Rekommenderas ej när persiennen monterats mellan fönsterglasen.

### KLASSISKOCHTIDLÖS

Standardfärgen 065 är en halvblank vit färg som är en klassisk och tidlös nyans som passar in i de flesta fönster och inredningar. Den är perfekt för den som vill ha en ren och fräsch känsla i sitt hem eller sin arbetsplats. Med sin neutrala ton kan 065 kombineras med en mängd olika färger och mönster i inredningen och skapar en harmonisk och avslappnad atmosfär.

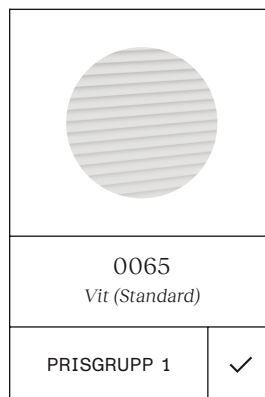



FÄRG PÅ BILD ÄR 049 - SVART

|                                                                                     |   |
|-------------------------------------------------------------------------------------|---|
|  |   |
| 0001<br>Vit                                                                         |   |
| PRISGRUPP 2                                                                         | ✕ |

|                                                                                     |   |
|-------------------------------------------------------------------------------------|---|
|  |   |
| 0012<br>Ljusgrå                                                                     |   |
| PRISGRUPP 2                                                                         | ✕ |

|                                                                                     |   |
|-------------------------------------------------------------------------------------|---|
|  |   |
| 0017<br>Silver                                                                      |   |
| PRISGRUPP 2                                                                         | ✕ |

|                                                                                     |   |
|-------------------------------------------------------------------------------------|---|
|  |   |
| 0049*<br>Svart                                                                      |   |
| PRISGRUPP 2                                                                         | ✕ |

|                                                                                     |   |
|-------------------------------------------------------------------------------------|---|
|  |   |
| 0051<br>Grå linnemönstrad                                                           |   |
| PRISGRUPP 5                                                                         | ✕ |

|                                                                                     |   |
|-------------------------------------------------------------------------------------|---|
|  |   |
| 0058<br>Silver                                                                      |   |
| PRISGRUPP 2                                                                         | ✕ |

|                                                                                       |   |
|---------------------------------------------------------------------------------------|---|
|  |   |
| 0060<br>Brun                                                                          |   |
| PRISGRUPP 2                                                                           | ✕ |

|                                                                                       |   |
|---------------------------------------------------------------------------------------|---|
|  |   |
| 0085<br>Grå trä mönstrad                                                              |   |
| PRISGRUPP 5                                                                           | ✕ |

|                                                                                       |   |
|---------------------------------------------------------------------------------------|---|
|  |   |
| 0087<br>Brun trä mönstrad                                                             |   |
| PRISGRUPP 5                                                                           | ✕ |

|                           |   |
|---------------------------|---|
|                           |   |
| 058P<br>Silver perforerad |   |
| PRISGRUPP 5               | ✕ |

|                        |   |
|------------------------|---|
|                        |   |
| 065P<br>Vit perforerad |   |
| PRISGRUPP 5            | ✕ |

|               |   |
|---------------|---|
|               |   |
| 0023<br>Beige |   |
| PRISGRUPP 2   | ✕ |

|              |   |
|--------------|---|
|              |   |
| 0027<br>Brun |   |
| PRISGRUPP 4  | ✕ |

|                         |   |
|-------------------------|---|
|                         |   |
| 0032<br>Silver metallic |   |
| PRISGRUPP 4             | ✕ |

|                   |   |
|-------------------|---|
|                   |   |
| 0084<br>Champagne |   |
| PRISGRUPP 4       | ✕ |

|                 |   |
|-----------------|---|
|                 |   |
| 0244<br>Mörkgrå |   |
| PRISGRUPP 2     | ✕ |

|                 |   |
|-----------------|---|
|                 |   |
| 0258<br>Mörkblå |   |
| PRISGRUPP 4     | ✕ |

|               |   |
|---------------|---|
|               |   |
| 0285<br>Beige |   |
| PRISGRUPP 2   | ✕ |





|                       |   |
|-----------------------|---|
|                       |   |
| 0714<br>Guld metallic |   |
| PRISGRUPP 3           | ✕ |

|                        |   |
|------------------------|---|
|                        |   |
| 0739*<br>Vit/svart duo |   |
| PRISGRUPP 3            | ✕ |

|                   |   |
|-------------------|---|
|                   |   |
| 0870<br>Aluminium |   |
| PRISGRUPP 5       | ✕ |

|             |   |
|-------------|---|
|             |   |
| 0896<br>Vit |   |
| PRISGRUPP 2 | ✕ |

|                        |   |
|------------------------|---|
|                        |   |
| 0028<br>Vit/silver duo |   |
| PRISGRUPP 4            | ✕ |

|                 |   |
|-----------------|---|
|                 |   |
| 0103<br>Ljusgrå |   |
| PRISGRUPP 2     | ✕ |

|             |   |
|-------------|---|
|             |   |
| 0104<br>Grå |   |
| PRISGRUPP 2 | ✕ |

|                 |   |
|-----------------|---|
|                 |   |
| 1901<br>Mörkgrå |   |
| PRISGRUPP 3     | ✕ |

# FÄRGKOLLEKTION

Lina & stegband

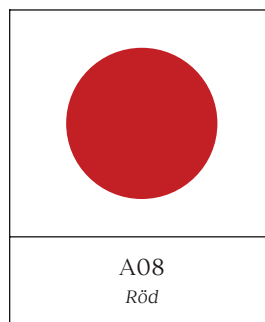
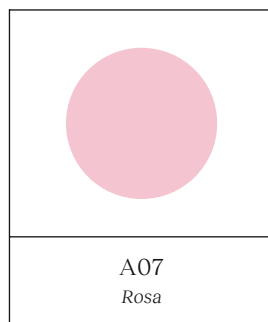
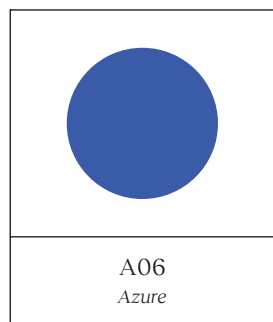
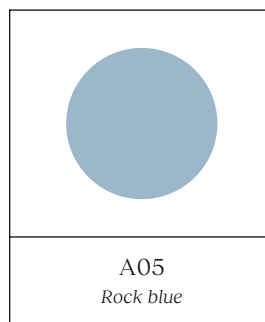
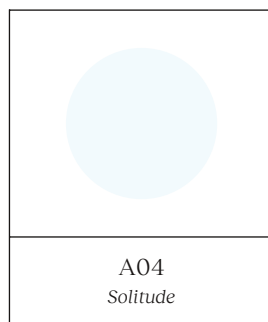
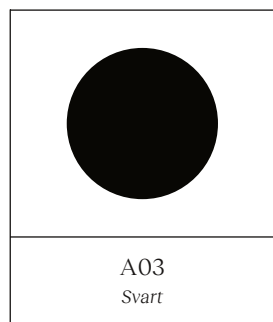
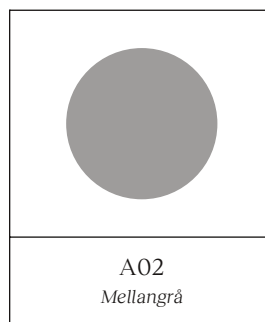
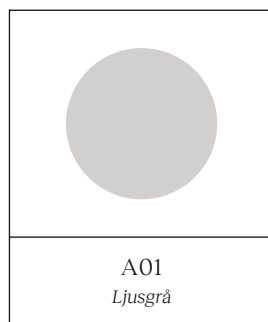
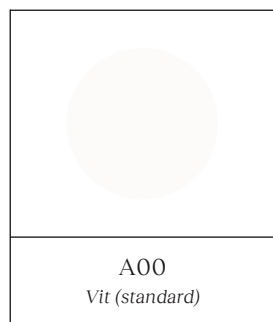

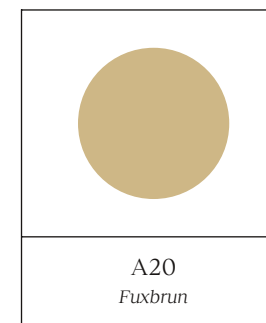
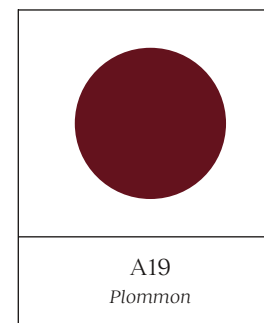
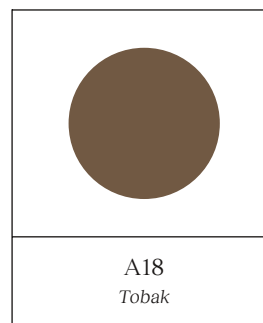
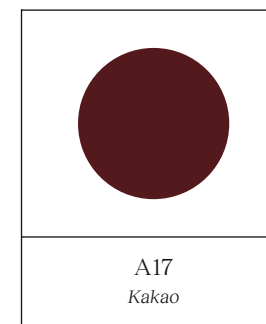
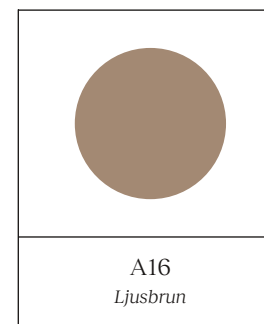
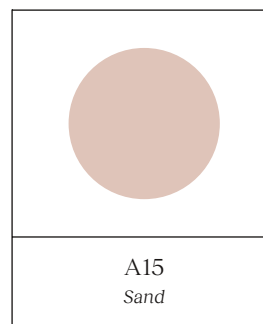
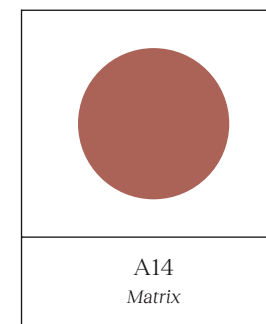
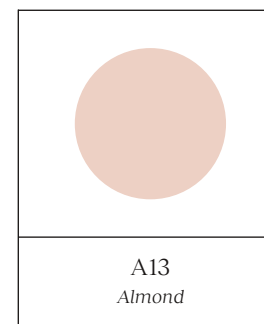
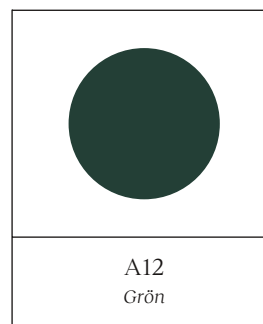
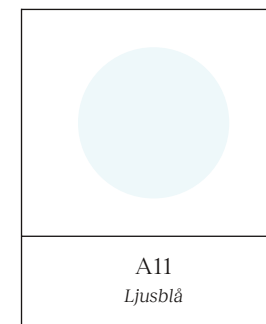
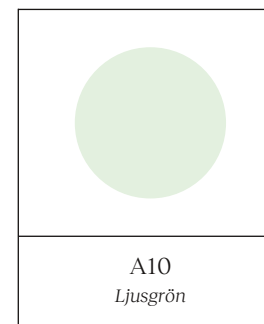
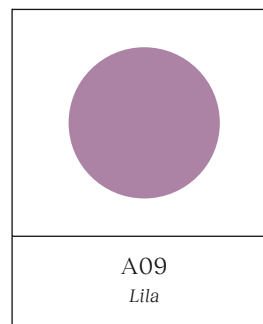

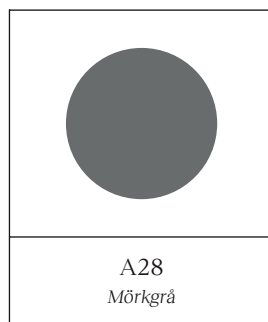
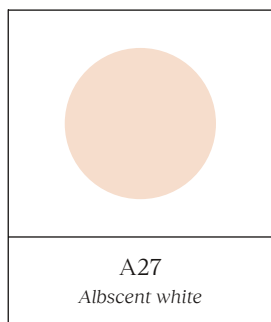
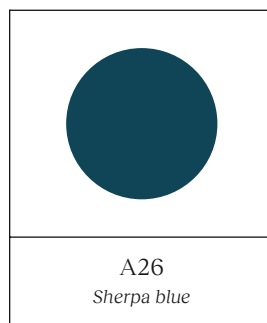
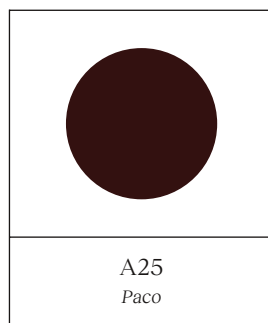
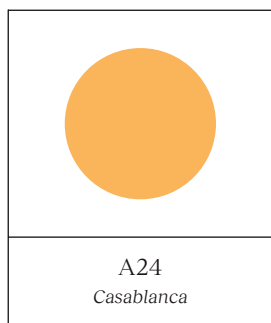
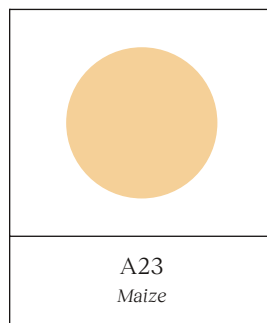
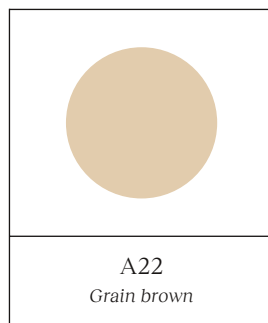
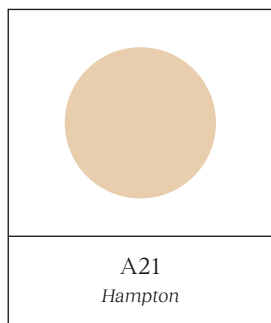



# FÄRGKOLLEKTION

## Plisséväv

Med sin veckade design ger plisségardinen en mer ombonad och inredd känsla i fönstren. Ett modernt solskydd med en härlig textilkänsla. Plissévävar finns i olika material och transparentnivåer så att du kan välja den som passar bäst för dina behov.

## PRISGRUPPER

PRISGRUPP PE



PRISGRUPP P2



PRISGRUPP P1



## EGENSKAPER

- Ultratransparent
- Transparent
- Semitransparent
- Mörkläggande

P Prisgrupper

Lämplig i fuktig miljö

Flamskyddad

|                             |  |
|-----------------------------|--|
|                             |  |
| Amazon 2700<br>Vit Mönstrad |  |
| P1                          |  |

|                                    |  |
|------------------------------------|--|
|                                    |  |
| Amazon 2703<br>Beige, Vit Mönstrad |  |
| P1                                 |  |

|                               |  |
|-------------------------------|--|
|                               |  |
| Aukland 9682<br>Grön Mönstrad |  |
| P2                            |  |

|                           |  |
|---------------------------|--|
|                           |  |
| Bari 5450<br>Vit Enfärgad |  |
| P1                        |  |

|                                |  |
|--------------------------------|--|
|                                |  |
| Bari 5453<br>Blå, Grå Enfärgad |  |
| P1                             |  |

|                           |  |
|---------------------------|--|
|                           |  |
| Bari 5454<br>Grå Enfärgad |  |
| P1                        |  |

|                           |  |
|---------------------------|--|
|                           |  |
| Bari 5457<br>Röd Enfärgad |  |
| P1                        |  |

|                                    |  |
|------------------------------------|--|
|                                    |  |
| Bari 5459<br>Vinnröd, Röd Enfärgad |  |
| P1                                 |  |

|                             |  |
|-----------------------------|--|
|                             |  |
| Bari 5461<br>Svart Enfärgad |  |
| P1                          |  |





VÄVAR PÅ BILD ÄR FRÅN KATEGORIN METALLISERADE

|                             |  |  |  |
|-----------------------------|--|--|--|
|                             |  |  |  |
| Bari 5467<br>Beige Enfärgad |  |  |  |
| P1                          |  |  |  |

|                            |  |  |  |
|----------------------------|--|--|--|
|                            |  |  |  |
| Bari 5468<br>Rosa Enfärgad |  |  |  |
| P1                         |  |  |  |

|                            |  |  |  |
|----------------------------|--|--|--|
|                            |  |  |  |
| Bari 5472<br>Grön Enfärgad |  |  |  |
| P1                         |  |  |  |

|                            |  |  |  |
|----------------------------|--|--|--|
|                            |  |  |  |
| Basel 1200<br>Vit Enfärgad |  |  |  |
| PE                         |  |  |  |

|                            |  |  |  |
|----------------------------|--|--|--|
|                            |  |  |  |
| Basel 1213<br>Grå Enfärgad |  |  |  |
| PE                         |  |  |  |

|                              |  |  |  |
|------------------------------|--|--|--|
|                              |  |  |  |
| Basel 1215<br>Svart Enfärgad |  |  |  |
| PE                           |  |  |  |



|                                       |  |  |  |
|---------------------------------------|--|--|--|
|                                       |  |  |  |
| Basel 1216<br>Mörkbrun, Brun Enfärgad |  |  |  |
| PE                                    |  |  |  |

|                                     |  |  |  |
|-------------------------------------|--|--|--|
|                                     |  |  |  |
| Basel 1217<br>Mörkgrå, Grå Enfärgad |  |  |  |
| PE                                  |  |  |  |

|                                         |  |  |  |
|-----------------------------------------|--|--|--|
|                                         |  |  |  |
| Basel 1218<br>Ljusbeige, Beige Enfärgad |  |  |  |
| PE                                      |  |  |  |



Basel 1220  
Vit Enfärgad

PE   



Basel 1230  
Marinblå, Blå Enfärgad

PE   



Basel 1239  
Brun Enfärgad

PE   





Basel 1243  
Grå Enfärgad

PE   



Crush Pearl 10449  
Vit Struktur

P1  



Crush Pearl 10450  
Beige Struktur

P1  





Crush Pearl 10453  
Brun Struktur

P1  



Crush Pearl 5174  
Vit Struktur

P1  



Crush Pearl 7004  
Ljusgrå, Grå Struktur

P1  



Crush Pearl 7081  
Svart Struktur

P1  



Crush Pearl 7100  
Mörkgrå, Grå Struktur

P1  



Frankfurt 7000  
Ljusgrå, Silver Enfärgad

P2   



Frankfurt 7002  
Beige, Silver Enfärgad

P2   



Frankfurt 7003  
Mörkgrå, Silver Enfärgad

P2   



Frankfurt 7010  
Svart, Silver Enfärgad

P2   



Frankfurt 7099  
Silver Enfärgad

P2   



Jaipur 6203  
Beige Mönstrad

P1  



Jaipur 6204  
Ljusgrå, Grå Mönstrad

P1  

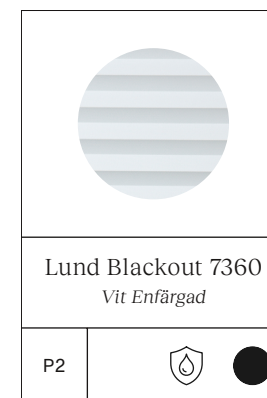
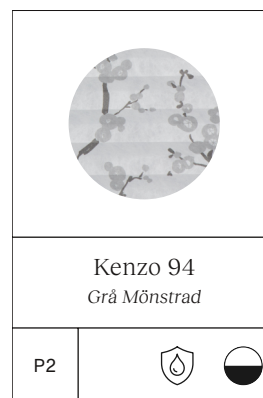
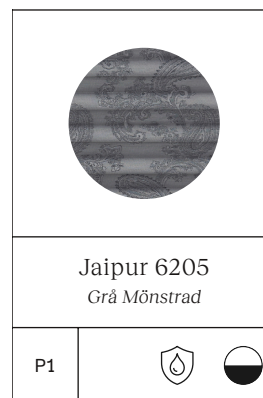





Lund Blackout 7371  
*Blå Enfärgad*

P2  



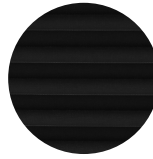

Lund Blackout 7376  
*Vit Enfärgad*

P2  



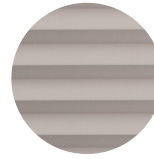

Lund Blackout 7377  
*Svart Enfärgad*

P2  



Lund Blackout 7379  
*Beige Enfärgad*

P2  



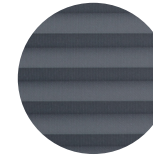

Lund Blackout 7389  
*Ljusgrå,Grå Enfärgad*

P2  



Lund Blackout 7390  
*Grå Enfärgad*

P2  



Milano 7910  
*Vit Struktur*

P1   



Milano 7911  
*Beige Struktur*

P1   



Milano 7912  
*Ljusbeige,Beige Struktur*

P1   



Milano 7914  
*Rosa Struktur*

P1   



Milano 7919  
*Grön Struktur*

P1   



Milano 7928  
*Blå,Grå Struktur*

P1   



Milano 7929  
*Ljusgrå,Grå Struktur*

P1   



Nevada 8900  
*Brun Struktur*

P2  



Nevada 8902  
*Beige,Grå Struktur*

P2  



Nevada 8903  
*Beige Struktur*

P2  



Nevada 8905  
*Ljusgrå,Grå Struktur*

P2  



New York 7100  
*Ljusgrå,Silver Enfärgad*

P2   



VÄVAR PÅ BILD ÄR FRÅN KATEGORIN VITT & NATUR

|                                         |  |  |  |
|-----------------------------------------|--|--|--|
|                                         |  |  |  |
| New York 7102<br>Beige, Silver Enfärgad |  |  |  |
| P2                                      |  |  |  |

|                                           |  |  |  |
|-------------------------------------------|--|--|--|
|                                           |  |  |  |
| New York 7103<br>Mörkgrå, Silver Enfärgad |  |  |  |
| P2                                        |  |  |  |

|                                         |  |  |  |
|-----------------------------------------|--|--|--|
|                                         |  |  |  |
| New York 7110<br>Svart, Silver Enfärgad |  |  |  |
| P2                                      |  |  |  |

|                                  |  |  |  |
|----------------------------------|--|--|--|
|                                  |  |  |  |
| New York 7199<br>Silver Enfärgad |  |  |  |
| P2                               |  |  |  |

|                             |  |  |  |
|-----------------------------|--|--|--|
|                             |  |  |  |
| Opera 10230<br>Vit Enfärgad |  |  |  |
| P1                          |  |  |  |

|                             |  |  |  |
|-----------------------------|--|--|--|
|                             |  |  |  |
| Opera 10274<br>Grå Enfärgad |  |  |  |
| P1                          |  |  |  |

|                                      |  |  |  |
|--------------------------------------|--|--|--|
|                                      |  |  |  |
| Opera 10296<br>Mörkgrå, Grå Enfärgad |  |  |  |
| P1                                   |  |  |  |

|                            |  |  |  |
|----------------------------|--|--|--|
|                            |  |  |  |
| Ordos 8924<br>Grå Struktur |  |  |  |
| P2                         |  |  |  |

|                              |  |  |  |
|------------------------------|--|--|--|
|                              |  |  |  |
| Palermo 5020<br>Vit Struktur |  |  |  |
| P2                           |  |  |  |

|                              |  |
|------------------------------|--|
|                              |  |
| Palermo 5026<br>Grå Struktur |  |
| P2                           |  |

|                              |  |
|------------------------------|--|
|                              |  |
| Palermo 5031<br>Blå Struktur |  |
| P2                           |  |

|                              |  |
|------------------------------|--|
|                              |  |
| Palermo 5033<br>Grå Struktur |  |
| P2                           |  |

|                             |  |
|-----------------------------|--|
|                             |  |
| Seto 7750<br>Beige Struktur |  |
| P2                          |  |

|                            |  |
|----------------------------|--|
|                            |  |
| Seto 7805<br>Brun Struktur |  |
| P2                         |  |

|                              |  |
|------------------------------|--|
|                              |  |
| Sinai 8202<br>Beige Struktur |  |
| P1                           |  |

|                                     |  |
|-------------------------------------|--|
|                                     |  |
| Sinai 8206<br>Ljusgrå, Grå Struktur |  |
| P1                                  |  |

|                                   |  |
|-----------------------------------|--|
|                                   |  |
| Sinai 8207<br>Beige, Grå Struktur |  |
| P1                                |  |

|                                     |  |
|-------------------------------------|--|
|                                     |  |
| Sinai 8208<br>Ljusgrå, Grå Struktur |  |
| P1                                  |  |

|                                     |  |
|-------------------------------------|--|
|                                     |  |
| Tigris Pearl 1450<br>Beige Struktur |  |
| P1                                  |  |

|                                     |  |
|-------------------------------------|--|
|                                     |  |
| Tigris Pearl 1452<br>Beige Struktur |  |
| P1                                  |  |

|                                            |  |
|--------------------------------------------|--|
|                                            |  |
| Tigris Pearl 1455<br>Ljusgrå, Grå Struktur |  |
| P1                                         |  |

|                                   |  |
|-----------------------------------|--|
|                                   |  |
| Tigris Pearl 1462<br>Grå Struktur |  |
| P1                                |  |

|                                    |  |
|------------------------------------|--|
|                                    |  |
| Tigris Pearl 1464<br>Brun Struktur |  |
| P1                                 |  |

|                                    |  |
|------------------------------------|--|
|                                    |  |
| Tigris Pearl 1472<br>Rosa Struktur |  |
| P1                                 |  |

|                               |  |
|-------------------------------|--|
|                               |  |
| Tirari 6640<br>Beige Struktur |  |
| P1                            |  |

|                             |  |
|-----------------------------|--|
|                             |  |
| Tirari 6641<br>Grå Struktur |  |
| P1                          |  |

|                                    |  |
|------------------------------------|--|
|                                    |  |
| Valencia 2730<br>Vit, Grå Mönstrad |  |
| P1                                 |  |



|                                             |  |
|---------------------------------------------|--|
|                                             |  |
| Valencia 2731<br><i>Vit, Beige Mönstrad</i> |  |
| P1                                          |  |

|                                       |  |
|---------------------------------------|--|
|                                       |  |
| Venedig 4102<br><i>Beige Enfärgad</i> |  |
| P1                                    |  |

|                                     |  |
|-------------------------------------|--|
|                                     |  |
| Venedig 4108<br><i>Vit Enfärgad</i> |  |
| P1                                  |  |

|                                       |  |
|---------------------------------------|--|
|                                       |  |
| Venedig 4112<br><i>Beige Enfärgad</i> |  |
| P1                                    |  |

# FÄRGKOLLEKTION

## Honeycellväv

Ett veckat solskydd i dubbla vävlager som liknar en bikupekonstruktion, vilket ger en isolerande effekt. Honeycellväv finns i olika material och transparentnivåer så att du kan välja den som passar bäst för dina behov.

## PRISGRUPPER

### PRISGRUPP HE



### PRISGRUPP H2



### PRISGRUPP H4



### PRISGRUPP H1



### PRISGRUPP H3



## EGENSKAPER

- Ultratransparent
- Transparent
- Semitransparent
- Mörkläggande

H Prisgrupper

 Lämplig i fuktig miljö

 Flamskyddad



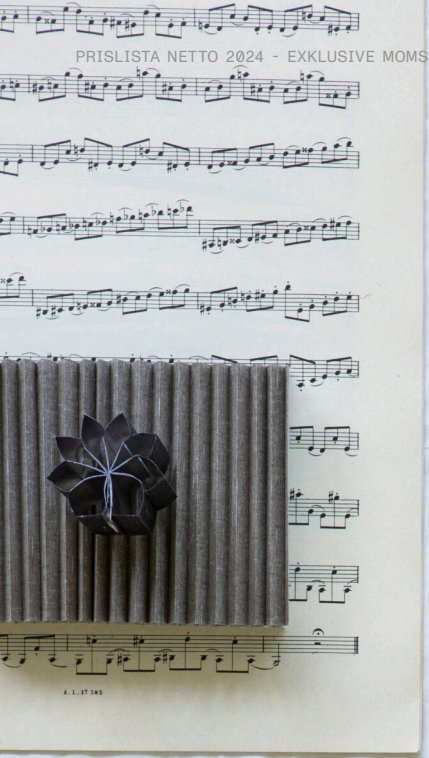

|                              |  |  |  |
|------------------------------|--|--|--|
|                              |  |  |  |
| Atlanta 7560<br>Vit Enfärgad |  |  |  |
| H3                           |  |  |  |

|                                |  |  |  |
|--------------------------------|--|--|--|
|                                |  |  |  |
| Atlanta 7563<br>Beige Enfärgad |  |  |  |
| H3                             |  |  |  |

|                              |  |  |  |
|------------------------------|--|--|--|
|                              |  |  |  |
| Atlanta 7570<br>Grå Enfärgad |  |  |  |
| H3                           |  |  |  |

|                              |  |  |  |
|------------------------------|--|--|--|
|                              |  |  |  |
| Atlanta 7590<br>Grå Enfärgad |  |  |  |
| H3                           |  |  |  |

|                                 |  |  |  |
|---------------------------------|--|--|--|
|                                 |  |  |  |
| Atlanta BO 7660<br>Vit Enfärgad |  |  |  |
| H4                              |  |  |  |

|                                   |  |  |  |
|-----------------------------------|--|--|--|
|                                   |  |  |  |
| Atlanta BO 7662<br>Beige Enfärgad |  |  |  |
| H4                                |  |  |  |

|                                   |  |  |  |
|-----------------------------------|--|--|--|
|                                   |  |  |  |
| Atlanta BO 7669<br>Svart Enfärgad |  |  |  |
| H4                                |  |  |  |

|                                          |  |  |  |
|------------------------------------------|--|--|--|
|                                          |  |  |  |
| Atlanta BO 7691<br>Mörkgrå, Grå Enfärgad |  |  |  |
| H4                                       |  |  |  |

|                                   |  |  |  |
|-----------------------------------|--|--|--|
|                                   |  |  |  |
| Burlington 5541<br>Beige Struktur |  |  |  |
| H2                                |  |  |  |

|                                                 |  |
|-------------------------------------------------|--|
|                                                 |  |
| Burlington 5542<br><i>Ljusgrå, Grå Struktur</i> |  |
| H2                                              |  |

|                                                 |  |
|-------------------------------------------------|--|
|                                                 |  |
| Burlington 5543<br><i>Mörkgrå, Grå Struktur</i> |  |
| H2                                              |  |

|                                             |  |
|---------------------------------------------|--|
|                                             |  |
| Burlington BO 5561<br><i>Beige Struktur</i> |  |
| H3                                          |  |

|                                                    |  |
|----------------------------------------------------|--|
|                                                    |  |
| Burlington BO 5562<br><i>Ljusgrå, Grå Struktur</i> |  |
| H3                                                 |  |

|                                                    |  |
|----------------------------------------------------|--|
|                                                    |  |
| Burlington BO 5563<br><i>Mörkgrå, Grå Struktur</i> |  |
| H3                                                 |  |

|                                             |  |
|---------------------------------------------|--|
|                                             |  |
| Burlington BO 5569<br><i>Svart Struktur</i> |  |
| H3                                          |  |

|                                               |  |
|-----------------------------------------------|--|
|                                               |  |
| Edmonton 5509<br><i>Ljusgrå, Grå Struktur</i> |  |
| H3                                            |  |

|                                      |  |
|--------------------------------------|--|
|                                      |  |
| Edmonton 5510<br><i>Grå Struktur</i> |  |
| H3                                   |  |

|                                        |  |
|----------------------------------------|--|
|                                        |  |
| Edmonton 5514<br><i>Beige Struktur</i> |  |
| H3                                     |  |

|                                             |  |
|---------------------------------------------|--|
|                                             |  |
| Edmonton 5515<br><i>Beige, Grå Struktur</i> |  |
| H3                                          |  |

|                                       |  |
|---------------------------------------|--|
|                                       |  |
| Halifax 5240<br><i>Beige Struktur</i> |  |
| H2                                    |  |

|                                      |  |
|--------------------------------------|--|
|                                      |  |
| Halifax 5241<br><i>Rosa Struktur</i> |  |
| H2                                   |  |

|                                     |  |
|-------------------------------------|--|
|                                     |  |
| Halifax 5242<br><i>Grå Struktur</i> |  |
| H2                                  |  |

|                                              |  |
|----------------------------------------------|--|
|                                              |  |
| Halifax 5243<br><i>Ljusgrå, Grå Struktur</i> |  |
| H2                                           |  |

|                                     |  |
|-------------------------------------|--|
|                                     |  |
| Halifax 5244<br><i>Blå Struktur</i> |  |
| H2                                  |  |

|                                      |  |
|--------------------------------------|--|
|                                      |  |
| Halifax 5245<br><i>Grön Struktur</i> |  |
| H2                                   |  |

|                                          |  |
|------------------------------------------|--|
|                                          |  |
| Halifax BO 5260<br><i>Beige Struktur</i> |  |
| H3                                       |  |

|                                         |  |
|-----------------------------------------|--|
|                                         |  |
| Halifax BO 5261<br><i>Rosa Struktur</i> |  |
| H3                                      |  |



|                                 |  |  |
|---------------------------------|--|--|
|                                 |  |  |
| Halifax BO 5262<br>Grå Struktur |  |  |
| H3                              |  |  |

|                                          |  |  |
|------------------------------------------|--|--|
|                                          |  |  |
| Halifax BO 5263<br>Ljusgrå, Grå Struktur |  |  |
| H3                                       |  |  |

|                                 |  |  |
|---------------------------------|--|--|
|                                 |  |  |
| Halifax BO 5264<br>Blå Struktur |  |  |
| H3                              |  |  |

|                                  |  |  |
|----------------------------------|--|--|
|                                  |  |  |
| Halifax BO 5265<br>Grön Struktur |  |  |
| H3                               |  |  |

|                               |  |  |
|-------------------------------|--|--|
|                               |  |  |
| Hamilton 5360<br>Vit Enfärgad |  |  |
| H4                            |  |  |

|                               |  |  |
|-------------------------------|--|--|
|                               |  |  |
| Hamilton 5363<br>Grå Enfärgad |  |  |
| H4                            |  |  |

|                               |  |  |
|-------------------------------|--|--|
|                               |  |  |
| Hamilton 5364<br>Grå Enfärgad |  |  |
| H4                            |  |  |

|                                 |  |  |
|---------------------------------|--|--|
|                                 |  |  |
| Hamilton 5367<br>Beige Enfärgad |  |  |
| H4                              |  |  |

|                               |  |  |
|-------------------------------|--|--|
|                               |  |  |
| Hamilton 5368<br>Vit Enfärgad |  |  |
| H4                            |  |  |

|                                     |                                                                                                                                                                     |
|-------------------------------------|---------------------------------------------------------------------------------------------------------------------------------------------------------------------|
|                                     |                                                                                                                                                                     |
| Mistral 7410<br><i>Vit Enfärgad</i> |                                                                                                                                                                     |
| HE                                  |   |

|                                       |                                                                                                                                                                     |
|---------------------------------------|---------------------------------------------------------------------------------------------------------------------------------------------------------------------|
|                                       |                                                                                                                                                                     |
| Mistral 7412<br><i>Beige Enfärgad</i> |                                                                                                                                                                     |
| HE                                    |   |

|                                       |                                                                                                                                                                       |
|---------------------------------------|-----------------------------------------------------------------------------------------------------------------------------------------------------------------------|
|                                       |                                                                                                                                                                       |
| Mistral 7415<br><i>Beige Enfärgad</i> |                                                                                                                                                                       |
| HE                                    |   |

|                                       |                                                                                                                                                                         |
|---------------------------------------|-------------------------------------------------------------------------------------------------------------------------------------------------------------------------|
|                                       |                                                                                                                                                                         |
| Mistral 7416<br><i>Beige Enfärgad</i> |                                                                                                                                                                         |
| HE                                    |   |

|                                                |                                                                                                                                                                         |
|------------------------------------------------|-------------------------------------------------------------------------------------------------------------------------------------------------------------------------|
|                                                |                                                                                                                                                                         |
| Mistral 7417<br><i>Ljusbrun, Brun Enfärgad</i> |                                                                                                                                                                         |
| HE                                             |   |

|                                      |                                                                                                                                                                         |
|--------------------------------------|-------------------------------------------------------------------------------------------------------------------------------------------------------------------------|
|                                      |                                                                                                                                                                         |
| Mistral 7419<br><i>Brun Enfärgad</i> |                                                                                                                                                                         |
| HE                                   |   |

|                                       |                                                                                                                                                                       |
|---------------------------------------|-----------------------------------------------------------------------------------------------------------------------------------------------------------------------|
|                                       |                                                                                                                                                                       |
| Mistral 7420<br><i>Svart Enfärgad</i> |                                                                                                                                                                       |
| HE                                    |   |

|                                              |                                                                                                                                                                       |
|----------------------------------------------|-----------------------------------------------------------------------------------------------------------------------------------------------------------------------|
|                                              |                                                                                                                                                                       |
| Mistral 7421<br><i>Mörkgrå, Grå Enfärgad</i> |                                                                                                                                                                       |
| HE                                           |   |

|                                          |                                                                                                                                                                         |
|------------------------------------------|-------------------------------------------------------------------------------------------------------------------------------------------------------------------------|
|                                          |                                                                                                                                                                         |
| Mistral 7422<br><i>Blå, Grå Enfärgad</i> |                                                                                                                                                                         |
| HE                                       |   |



|                                              |                                                                                                                                                                           |
|----------------------------------------------|---------------------------------------------------------------------------------------------------------------------------------------------------------------------------|
|                                              |                                                                                                                                                                           |
| Mistral 7423<br><i>Ljusgrå, Grå Enfärgad</i> |                                                                                                                                                                           |
| HE                                           |   |



|                                             |                                                                                                                                                                           |
|---------------------------------------------|---------------------------------------------------------------------------------------------------------------------------------------------------------------------------|
|                                             |                                                                                                                                                                           |
| Mistral 7425<br><i>Turkos, Blå Enfärgad</i> |                                                                                                                                                                           |
| HE                                          |   |



|                                     |                                                                                                                                                                           |
|-------------------------------------|---------------------------------------------------------------------------------------------------------------------------------------------------------------------------|
|                                     |                                                                                                                                                                           |
| Mistral 7427<br><i>Blå Enfärgad</i> |                                                                                                                                                                           |
| HE                                  |   |

|                                              |                                                                                                                                                                         |
|----------------------------------------------|-------------------------------------------------------------------------------------------------------------------------------------------------------------------------|
|                                              |                                                                                                                                                                         |
| Mistral 7428<br><i>Mörkblå, Blå Enfärgad</i> |                                                                                                                                                                         |
| HE                                           |   |

|                                      |                                                                                                                                                                         |
|--------------------------------------|-------------------------------------------------------------------------------------------------------------------------------------------------------------------------|
|                                      |                                                                                                                                                                         |
| Mistral 7429<br><i>Lila Enfärgad</i> |                                                                                                                                                                         |
| HE                                   |   |

|                                     |                                                                                                                                                                           |
|-------------------------------------|---------------------------------------------------------------------------------------------------------------------------------------------------------------------------|
|                                     |                                                                                                                                                                           |
| Mistral 7430<br><i>Röd Enfärgad</i> |                                                                                                                                                                           |
| HE                                  |   |

|                                        |                                                                                                                                                                             |
|----------------------------------------|-----------------------------------------------------------------------------------------------------------------------------------------------------------------------------|
|                                        |                                                                                                                                                                             |
| Mistral 7434<br><i>Orange Enfärgad</i> |                                                                                                                                                                             |
| HE                                     |   |

|                                     |                                                                                                                                                                             |
|-------------------------------------|-----------------------------------------------------------------------------------------------------------------------------------------------------------------------------|
|                                     |                                                                                                                                                                             |
| Mistral 7439<br><i>Gul Enfärgad</i> |                                                                                                                                                                             |
| HE                                  |   |

|                                      |                                                                                                                                                                             |
|--------------------------------------|-----------------------------------------------------------------------------------------------------------------------------------------------------------------------------|
|                                      |                                                                                                                                                                             |
| Mistral 7441<br><i>Grön Enfärgad</i> |                                                                                                                                                                             |
| HE                                   |   |

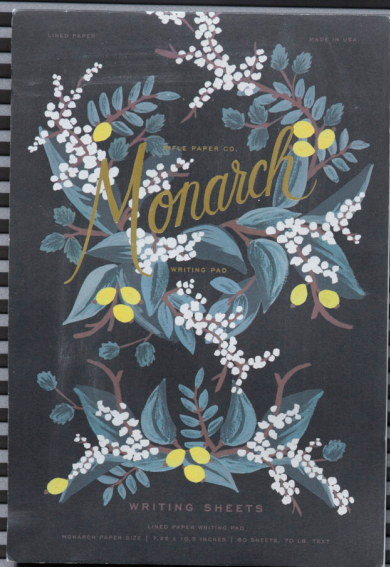

|                                        |                                                                                                                                                                         |
|----------------------------------------|-------------------------------------------------------------------------------------------------------------------------------------------------------------------------|
|                                        |                                                                                                                                                                         |
| Mistral BO 7460<br><i>Vit Enfärgad</i> |                                                                                                                                                                         |
| H2                                     |   |

|                                          |                                                                                                                                                                         |
|------------------------------------------|-------------------------------------------------------------------------------------------------------------------------------------------------------------------------|
|                                          |                                                                                                                                                                         |
| Mistral BO 7462<br><i>Beige Enfärgad</i> |                                                                                                                                                                         |
| H2                                       |   |

|                                          |                                                                                                                                                                         |
|------------------------------------------|-------------------------------------------------------------------------------------------------------------------------------------------------------------------------|
|                                          |                                                                                                                                                                         |
| Mistral BO 7465<br><i>Beige Enfärgad</i> |                                                                                                                                                                         |
| H2                                       |   |

|                                          |                                                                                                                                                                           |
|------------------------------------------|---------------------------------------------------------------------------------------------------------------------------------------------------------------------------|
|                                          |                                                                                                                                                                           |
| Mistral BO 7466<br><i>Beige Enfärgad</i> |                                                                                                                                                                           |
| H2                                       |   |

|                                                   |                                                                                                                                                                           |
|---------------------------------------------------|---------------------------------------------------------------------------------------------------------------------------------------------------------------------------|
|                                                   |                                                                                                                                                                           |
| Mistral BO 7467<br><i>Ljusbrun, Brun Enfärgad</i> |                                                                                                                                                                           |
| H2                                                |   |

|                                         |                                                                                                                                                                           |
|-----------------------------------------|---------------------------------------------------------------------------------------------------------------------------------------------------------------------------|
|                                         |                                                                                                                                                                           |
| Mistral BO 7469<br><i>Brun Enfärgad</i> |                                                                                                                                                                           |
| H2                                      |   |

|                                          |                                                                                                                                                                             |
|------------------------------------------|-----------------------------------------------------------------------------------------------------------------------------------------------------------------------------|
|                                          |                                                                                                                                                                             |
| Mistral BO 7470<br><i>Svart Enfärgad</i> |                                                                                                                                                                             |
| H2                                       |   |

|                                                 |                                                                                                                                                                             |
|-------------------------------------------------|-----------------------------------------------------------------------------------------------------------------------------------------------------------------------------|
|                                                 |                                                                                                                                                                             |
| Mistral BO 7471<br><i>Mörkgrå, Grå Enfärgad</i> |                                                                                                                                                                             |
| H2                                              |   |

|                                             |                                                                                                                                                                             |
|---------------------------------------------|-----------------------------------------------------------------------------------------------------------------------------------------------------------------------------|
|                                             |                                                                                                                                                                             |
| Mistral BO 7472<br><i>Blå, Grå Enfärgad</i> |                                                                                                                                                                             |
| H2                                          |   |

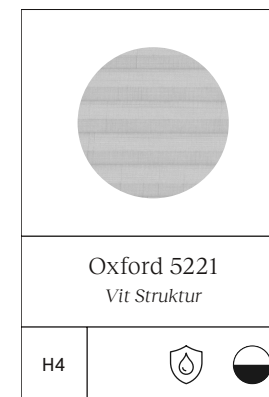
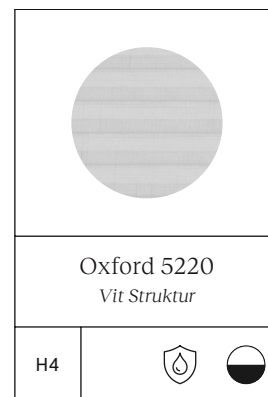
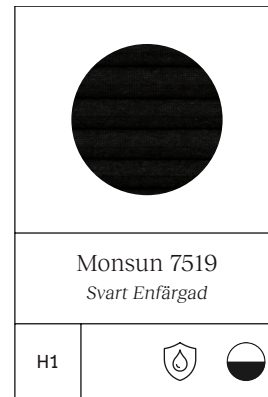
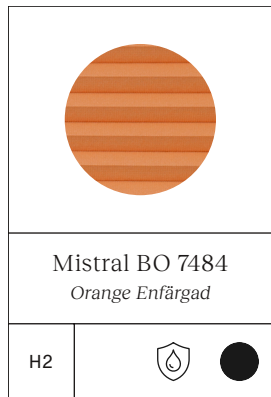
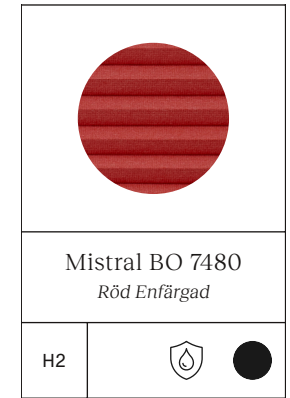



VÄVAR PÅ BILD ÄR FRÅN MISTRAL SERIEN

|                                      |  |
|--------------------------------------|--|
|                                      |  |
| Oxford 5226<br>Mörkgrå, Grå Struktur |  |
| H4                                   |  |

|                                    |  |
|------------------------------------|--|
|                                    |  |
| Oxford 5227<br>Grå, Svart Struktur |  |
| H4                                 |  |

|                             |  |
|-----------------------------|--|
|                             |  |
| Oxford 5228<br>Grå Struktur |  |
| H4                          |  |

|                               |  |
|-------------------------------|--|
|                               |  |
| Oxford 5229<br>Beige Struktur |  |
| H4                            |  |

|                            |  |
|----------------------------|--|
|                            |  |
| Rioja 7720<br>Vit Enfärgad |  |
| H1                         |  |

|                              |  |
|------------------------------|--|
|                              |  |
| Rioja 7725<br>Beige Enfärgad |  |
| H1                           |  |

|                              |  |
|------------------------------|--|
|                              |  |
| Rioja 7727<br>Svart Enfärgad |  |
| H1                           |  |

|                            |  |
|----------------------------|--|
|                            |  |
| Rioja 7728<br>Grå Enfärgad |  |
| H1                         |  |

|                            |  |
|----------------------------|--|
|                            |  |
| Rioja 7729<br>Blå Enfärgad |  |
| H1                         |  |



# INTU PERSIENN

Intu Persienn är en modern och elegant persienn med en integrerad manövrering utan synliga snören eller reglage. Den stilrena designen smälter in i alla typer av inredningar och den barnsäkra konstruktionen gör den till ett perfekt val för familjer med barn.

Intu Persienn är designad för att vara enkel och bekväma att använda och manövreras steglöst med en hand, utan

behov av extra detaljer. Den är enkel att installera med hjälp av gavelbeslagen på vardera sida som fästs i fönstrets båge eller karm.

Intu Persienn finns i flera olika färger. Du kan välja allt mellan klara starka färger, eleganta metallicfärger och mjuka ljusa pastellfärger i ett otal nyanser. Över- och underlist är som standard vit, men finns också i antracit, svart, silver och brun.

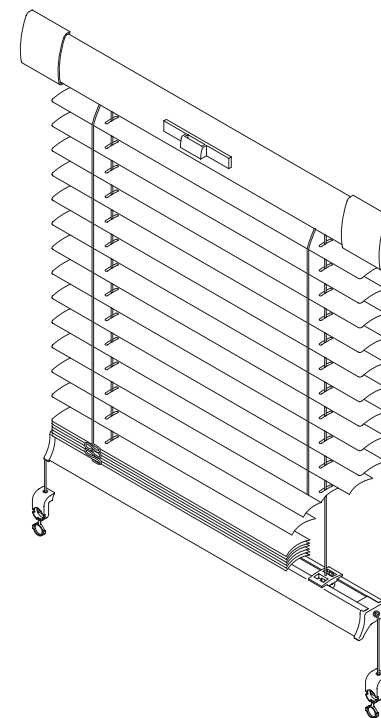

## SPECIFIKATIONER

### 2.5

MAX HÖJD (METER)

### 1.8

MAX BREDD (METER)

### 100

MINSTA HÖJD (MM)

### 220

MINSTA BREDD (MM)

### 2.5

MAX YTA (M2)

### 27\*

FÄRGER (LAMELL)

\*1 färg på över- och underlist

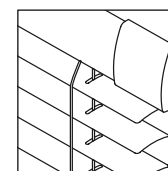

GAVELBESLAG

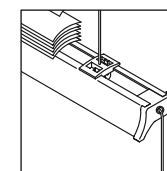

HANDMANÖVRERAD

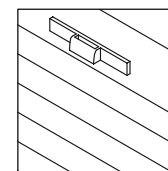

HANDTAG

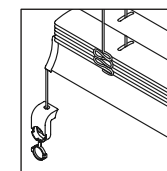

NEDRE FÄSTE FÖR LINA

## BREDD (MÅTT I MM)

|                        | 500               | 600 | 700 | 800              | 900               | 1000 | 1100 | 1200             | 1300               | 1400 | 1500 | 1600             | 1700 | 1800 |  |
|------------------------|-------------------|-----|-----|------------------|-------------------|------|------|------------------|--------------------|------|------|------------------|------|------|--|
| 500                    | 665               | 702 | 739 | 775              | 851               | 887  | 924  | 961              | 1035               | 1072 | 1166 | 1203             | 1239 | 1276 |  |
| 600                    | 670               | 708 | 746 | 784              | 860               | 898  | 936  | 973              | 1048               | 1086 | 1181 | 1219             | 1257 | 1294 |  |
| 700                    | 677               | 716 | 755 | 794              | 872               | 911  | 949  | 988              | 1065               | 1104 | 1200 | 1239             | 1278 | 1317 |  |
| 800                    | 684               | 724 | 764 | 804              | 883               | 923  | 963  | 1004             | 1081               | 1121 | 1219 | 1259             | 1299 | 1339 |  |
| 900                    | 689               | 730 | 772 | 813              | 893               | 934  | 975  | 1016             | 1094               | 1135 | 1234 | 1275             | 1316 | 1357 |  |
| 1000                   | 696               | 738 | 781 | 823              | 904               | 946  | 989  | 1031             | 1111               | 1153 | 1253 | 1295             | 1337 | 1379 |  |
| 1100                   | 703               | 746 | 790 | 833              | 916               | 959  | 1003 | 1046             | 1127               | 1170 | 1271 | 1315             | 1358 | 1402 |  |
| 1200                   | 708               | 753 | 797 | 842              | 925               | 970  | 1014 | 1058             | 1140               | 1184 | 1287 | 1331             | 1375 | 1420 |  |
| 1300                   | 715               | 761 | 806 | 852              | 937               | 982  | 1028 | 1073             | 1156               | 1202 | 1305 | 1351             | 1397 | 1442 |  |
| 1400                   | 722               | 769 | 815 | 862              | 948               | 995  | 1042 | 1089             | 1173               | 1219 | 1324 | 1371             | 1418 | X    |  |
| 1500                   | 727               | 775 | 823 | 870              | 958               | 1005 | 1053 | 1101             | 1186               | 1234 | 1340 | 1387             | X    | X    |  |
| 1600                   | 734               | 783 | 832 | 881              | 969               | 1018 | 1067 | 1116             | 1202               | 1251 | 1358 | X                | X    | X    |  |
| 1700                   | 741               | 791 | 841 | 891              | 981               | 1031 | 1081 | 1131             | 1218               | 1268 | X    | X                | X    | X    |  |
| 1800                   | 746               | 797 | 848 | 899              | 990               | 1041 | 1092 | 1143             | 1232               | 1283 | X    | X                | X    | X    |  |
| 1900                   | 753               | 805 | 857 | 910              | 1002              | 1054 | 1106 | 1159             | 1248               | X    | X    | X                | X    | X    |  |
| 2000                   | 760               | 813 | 867 | 920              | 1014              | 1067 | 1120 | 1174             | X                  | X    | X    | X                | X    | X    |  |
| 2100                   | 765               | 820 | 874 | 928              | 1023              | 1077 | 1132 | 1186             | X                  | X    | X    | X                | X    | X    |  |
| 2200                   | 772               | 828 | 883 | 939              | 1035              | 1090 | 1146 | X                | X                  | X    | X    | X                | X    | X    |  |
| 2300                   | 778               | 834 | 890 | 947              | 1044              | 1100 | 1157 | X                | X                  | X    | X    | X                | X    | X    |  |
| 2400                   | 784               | 842 | 900 | 957              | 1056              | 1113 | X    | X                | X                  | X    | X    | X                | X    | X    |  |
| 2500                   | 791               | 850 | 909 | 967              | 1067              | 1126 | X    | X                | X                  | X    | X    | X                | X    | X    |  |
| DISTANS                | 9                 | 9   | 9   | 9                | 9                 | 9    | 9    | 9                | 9                  | 9    | 9    | 9                | 9    | 9    |  |
| MANÖVERSTÅNG           | 300 MM: 217 KR/ST |     |     |                  | 600 MM: 217 KR/ST |      |      |                  | 1200 MM: 306 KR/ST |      |      |                  |      |      |  |
| PÅSLAG ALTERNATIV FÄRG | PRISGRUPP 2: 10%  |     |     | PRISGRUPP 3: 20% |                   |      |      | PRISGRUPP 4: 30% |                    |      |      | PRISGRUPP 5: 50% |      |      |  |

Listan avser - Prisgrupp 1 i kollektionen / Gavelbeslag och nedre fäste för lina ingår / Mått 10 mm över bredd & höjd kolumn debiteras efter närmast högre.

# INTU PERSIENN

## DETALJERAD SPECIFIKATION

|                      |                                                      |
|----------------------|------------------------------------------------------|
| ANVÄNDNINGSSOMRÅDE   | Villor, radhus, kontor, butiker, skolor och sjukhus. |
| MÅTT ÖVERLIST        | 27,6 mm x 37,2 mm                                    |
| MÅTT UNDERLIST       | 20 mm x 26,2 mm                                      |
| MÅTT LAMELL          | 0,19 mm x 25 mm                                      |
| MINSTA BREDD         | 220 mm                                               |
| MAX BREDD            | 1800 mm                                              |
| MINSTA HÖJD          | 100 mm                                               |
| MAX HÖJD             | 2500 mm                                              |
| MAX YTA              | 2,5 m <sup>2</sup>                                   |
| FÄRG PROFILER        | 27 färger (Lamell) / 1 färger (Över- & Underlist)    |
| FÄRG LINA & STEGBAND | 29 färger                                            |
| FÄRG DETALJER        | Vit                                                  |
| MONTERING            | På fönsterbågen eller karm                           |

|                  |                                                                                                                                              |
|------------------|----------------------------------------------------------------------------------------------------------------------------------------------|
| MONTERINGSBESLAG | Intubeslag                                                                                                                                   |
| MATERIAL         | - Över- & Underlist: Aluminium<br>- Lamell: Aluminium<br>- Lina & stegband: 100% polyester<br>- Detaljer: Plast<br>- Monteringsbeslag: Plast |

# INTU PLISSÉ

Intu Plissé skapar en ombonad och inredd känsla i dina fönster och är ett modernt solskydd med en härlig textilkänsla. Den veckade designen ger en elegant och sofistikerad look som passar perfekt i alla typer av inredningar.

Intu Plissé är enkel att installera med hjälp av gavelbeslagen på vardera sida som fästs i fönstrets båge eller karm. Den finns i både envägs- och tvåvägsfunktion, vilket ger dig fullständig kontroll över ljusinsläppet. Du kan enkelt manövrera den steglöst uppifrån

och nedifrån över hela fönstrets yta, vilket gör det enkelt att skapa den perfekta atmosfären i ditt hem.

Intu Plissé finns i flera olika färger och mönster, från neutrala toner som vitt och beige till livfulla nyanser som grönt, blått och gult. Genomsiktligheten finns i olika grader, från transparenta till mörkläggande. Över- och underlist är som standard vit, men finns också i antracit, svart, silver och brun.

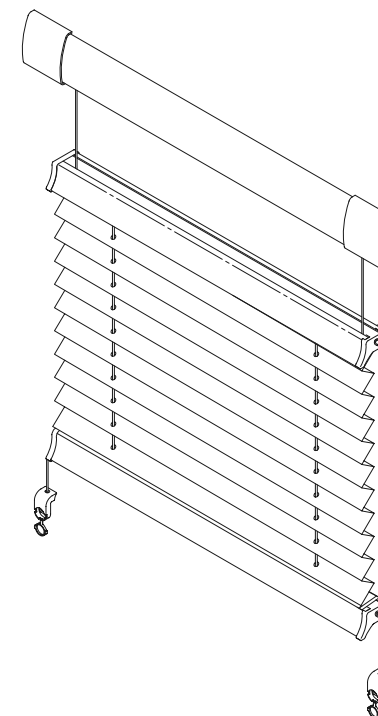

## SPECIFIKATIONER

### 2.5

MAX HÖJD (METER)

### 1.4

MAX BREDD (METER)

### 100

MINSTA HÖJD (MM)

### 160

MINSTA BREDD (MM)

### 2.5

MAX YTA (M2)

### 74\*

FÄRGER (PLISSÉVÄV)

\*1 färg på över- och underlist

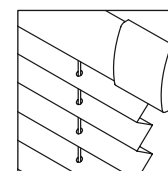

GAVELBESLAG

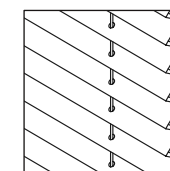

PLISSÉVÄV

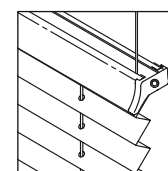

DUBBELFUNKTION

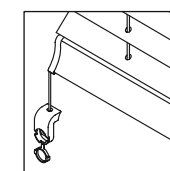

NEDRE FÄSTE FÖR LINA

|                  |                        | BREDD (MÅTT I MM) |      |      |                   |      |                   |                    |      |      |      |
|------------------|------------------------|-------------------|------|------|-------------------|------|-------------------|--------------------|------|------|------|
|                  |                        | 500               | 600  | 700  | 800               | 900  | 1000              | 1100               | 1200 | 1300 | 1400 |
| HÖJD (MÅTT I MM) | 500                    | 751               | 791  | 830  | 869               | 969  | 1009              | 1048               | 1088 | 1127 | 1166 |
|                  | 600                    | 758               | 799  | 840  | 880               | 982  | 1023              | 1063               | 1104 | 1145 | 1186 |
|                  | 700                    | 765               | 807  | 849  | 891               | 995  | 1037              | 1079               | 1121 | 1163 | 1205 |
|                  | 800                    | 772               | 816  | 859  | 902               | 1008 | 1051              | 1094               | 1138 | 1181 | 1224 |
|                  | 900                    | 779               | 824  | 869  | 913               | 1020 | 1065              | 1110               | 1154 | 1199 | 1243 |
|                  | 1000                   | 786               | 832  | 878  | 924               | 1033 | 1079              | 1125               | 1171 | 1217 | 1263 |
|                  | 1100                   | 793               | 841  | 888  | 935               | 1046 | 1093              | 1140               | 1188 | 1235 | 1282 |
|                  | 1200                   | 800               | 849  | 897  | 946               | 1059 | 1107              | 1156               | 1204 | 1253 | 1301 |
|                  | 1300                   | 807               | 857  | 907  | 957               | 1072 | 1121              | 1171               | 1221 | 1271 | 1320 |
|                  | 1400                   | 815               | 866  | 917  | 968               | 1084 | 1135              | 1186               | 1238 | 1289 | 1340 |
|                  | 1500                   | 822               | 874  | 926  | 979               | 1097 | 1149              | 1202               | 1254 | 1307 | 1359 |
|                  | 1600                   | 829               | 882  | 936  | 990               | 1110 | 1164              | 1217               | 1271 | 1325 | 1378 |
|                  | 1700                   | 836               | 891  | 946  | 1001              | 1123 | 1178              | 1233               | 1288 | 1343 | X    |
|                  | 1800                   | 843               | 899  | 955  | 1011              | 1135 | 1192              | 1248               | 1304 | 1360 | X    |
|                  | 1900                   | 850               | 907  | 965  | 1022              | 1148 | 1206              | 1263               | 1321 | X    | X    |
|                  | 2000                   | 857               | 916  | 974  | 1033              | 1161 | 1220              | 1279               | X    | X    | X    |
|                  | 2100                   | 864               | 924  | 984  | 1044              | 1174 | 1234              | 1294               | X    | X    | X    |
|                  | 2200                   | 871               | 932  | 994  | 1055              | 1187 | 1248              | X                  | X    | X    | X    |
|                  | 2300                   | 878               | 941  | 1003 | 1066              | 1199 | 1262              | X                  | X    | X    | X    |
|                  | 2400                   | 885               | 949  | 1013 | 1077              | 1212 | X                 | X                  | X    | X    | X    |
| 2500             | 892                    | 957               | 1023 | 1088 | 1225              | X    | X                 | X                  | X    | X    |      |
|                  | DUBBELFUNKTION         | 204               | 217  | 230  | 242               | 260  | 294               | 307                | 320  | 333  | 346  |
|                  | DISTANS                | 9                 | 9    | 9    | 9                 | 9    | 9                 | 9                  | 9    | 9    | 9    |
|                  | MANÖVERSTÅNG           | 300 MM: 217 KR/ST |      |      | 600 MM: 217 KR/ST |      |                   | 1200 MM: 306 KR/ST |      |      |      |
| TILLVAL          | PÅSLAG ALTERNATIV FÄRG | PRISGRUPP P1: 20% |      |      |                   |      | PRISGRUPP P2: 30% |                    |      |      |      |

Listan avser - Prisgrupp PE i kollektionen / Gavelbeslag och nedre fäste för lina ingår / Mått 10 mm över bredd & höjd kolumn debiteras efter närmast högre.

# INTU PLISSÉ

## DETALJERAD SPECIFIKATION

|                      |                                                      |
|----------------------|------------------------------------------------------|
| ANVÄNDNINGSOMRÅDE    | Villor, radhus, kontor, butiker, skolor och sjukhus. |
| MÅTT ÖVERLIST        | 27,6 mm x 37,2 mm                                    |
| MÅTT UNDERLIST       | 20,2 mm x 28,7 mm                                    |
| MINSTA BREDD         | 220 mm                                               |
| MAX BREDD            | 1400 mm                                              |
| MINSTA HÖJD          | 100 mm                                               |
| MAX HÖJD             | 2500 mm                                              |
| MAX YTA              | 2,5 m <sup>2</sup>                                   |
| FÄRG PROFILER        | 27 färger (Lamell) / 1 färger (Över- & Underlist)    |
| FÄRG LINA & STEGBAND | 29 färger                                            |
| FÄRG DETALJER        | Vit                                                  |
| MONTERING            | På fönsterbågen eller karm                           |

|                  |                                                                                                                                                                                                                                                                               |
|------------------|-------------------------------------------------------------------------------------------------------------------------------------------------------------------------------------------------------------------------------------------------------------------------------|
| MONTERINGSBESLAG | Intubeslag                                                                                                                                                                                                                                                                    |
| MATERIAL         | <ul style="list-style-type: none"> <li>- Över- &amp; Underlist: Aluminium</li> <li>- Väv: 100% polyester, 100% Trevira CS eller 95% polyester, 5% lin</li> <li>- Lina &amp; stegband: 100% polyester</li> <li>- Detaljer: Plast</li> <li>- Monteringsbeslag: Plast</li> </ul> |

# INTU HONEYCELL

Intu Honeycell skapar en ombonad och inredd känsla i dina fönster och är ett modernt solskydd med en härlig textilkänsla. Intu Honeycell har en veckad design i dubbla vävlager som liknar en bikupekonstruktion, vilket ger en isolerande effekt.

Intu Honeycell är enkel att installera med hjälp av gavelbeslagen på vardera sida som fästs i fönstrets båge eller karm. Den finns i både envägs- och tvåvägsfunktion, vilket ger dig fullständig kontroll över

ljusinsläppet. Du kan enkelt manövrera den steglöst uppifrån och nedifrån över hela fönstrets yta, vilket gör det enkelt att skapa den perfekta atmosfären i ditt hem.

Intu Honeycell finns i flera olika färger och mönster, från neutrala toner som vitt och beige till livfulla nyanser som grönt, blått och gult. Genomsiktligheten finns i olika grader, från transparenta till mörkläggande. Över- och underlist är som standard vit, men finns också i antracit, svart, silver och brun.

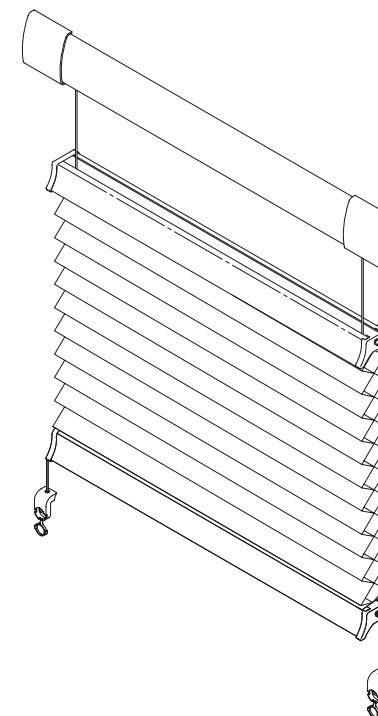

## SPECIFIKATIONER

### 2.5

MAX HÖJD (METER)

### 1.4

MAX BREDD (METER)

### 100

MINSTA HÖJD (MM)

### 160

MINSTA BREDD (MM)

### 2.5

MAX YTA (M2)

### 97\*

FÄRGER (LAMELL)

\*1 färg på över- och underlist

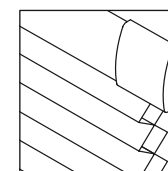

GAVELBESLAG

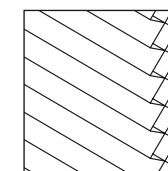

HONEYCELLVÄV

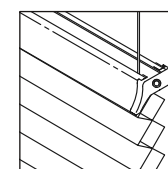

DUBBELFUNKTION

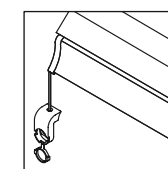

NEDRE FÄSTE FÖR LINA

|                  |      | BREDD (MÅTT I MM)      |                   |      |      |                   |      |      |                    |      |                   |     |
|------------------|------|------------------------|-------------------|------|------|-------------------|------|------|--------------------|------|-------------------|-----|
|                  |      | 500                    | 600               | 700  | 800  | 900               | 1000 | 1100 | 1200               | 1300 | 1400              |     |
| HÖJD (MÅTT I MM) | 500  | 792                    | 834               | 877  | 919  | 1025              | 1067 | 1110 | 1152               | 1195 | 1237              |     |
|                  | 600  | 806                    | 851               | 896  | 941  | 1050              | 1095 | 1140 | 1185               | 1231 | 1276              |     |
|                  | 700  | 820                    | 868               | 915  | 963  | 1075              | 1123 | 1171 | 1219               | 1266 | 1314              |     |
|                  | 800  | 834                    | 884               | 935  | 985  | 1101              | 1151 | 1202 | 1252               | 1302 | 1353              |     |
|                  | 900  | 848                    | 901               | 954  | 1007 | 1126              | 1179 | 1232 | 1285               | 1338 | 1392              |     |
|                  | 1000 | 862                    | 918               | 973  | 1029 | 1151              | 1207 | 1263 | 1319               | 1374 | 1430              |     |
|                  | 1100 | 876                    | 934               | 993  | 1051 | 1176              | 1235 | 1293 | 1352               | 1410 | 1469              |     |
|                  | 1200 | 890                    | 951               | 1012 | 1073 | 1202              | 1263 | 1324 | 1385               | 1446 | 1507              |     |
|                  | 1300 | 904                    | 968               | 1031 | 1095 | 1227              | 1291 | 1355 | 1418               | 1482 | 1546              |     |
|                  | 1400 | 918                    | 984               | 1051 | 1117 | 1252              | 1319 | 1385 | 1452               | 1518 | 1585              |     |
|                  | 1500 | 932                    | 1001              | 1070 | 1139 | 1277              | 1347 | 1416 | 1485               | 1554 | 1623              |     |
|                  | 1600 | 946                    | 1017              | 1089 | 1161 | 1303              | 1375 | 1446 | 1518               | 1590 | 1662              |     |
|                  | 1700 | 960                    | 1034              | 1109 | 1183 | 1328              | 1403 | 1477 | 1552               | 1626 | X                 |     |
|                  | 1800 | 974                    | 1051              | 1128 | 1205 | 1353              | 1430 | 1508 | 1585               | 1662 | X                 |     |
|                  | 1900 | 988                    | 1067              | 1147 | 1227 | 1379              | 1458 | 1538 | 1618               | X    | X                 |     |
|                  | 2000 | 1001                   | 1084              | 1167 | 1249 | 1404              | 1486 | 1569 | X                  | X    | X                 |     |
|                  | 2100 | 1015                   | 1101              | 1186 | 1271 | 1429              | 1514 | 1600 | X                  | X    | X                 |     |
|                  | 2200 | 1029                   | 1117              | 1205 | 1293 | 1454              | 1542 | X    | X                  | X    | X                 |     |
|                  | 2300 | 1043                   | 1134              | 1225 | 1315 | 1480              | 1570 | X    | X                  | X    | X                 |     |
|                  | 2400 | 1057                   | 1151              | 1244 | 1337 | 1505              | X    | X    | X                  | X    | X                 |     |
|                  | 2500 | 1071                   | 1167              | 1263 | 1359 | 1530              | X    | X    | X                  | X    | X                 |     |
|                  |      | DUBBELFUNKTION         | 204               | 217  | 230  | 242               | 260  | 294  | 307                | 320  | 333               | 346 |
|                  |      | DISTANS                | 9                 | 9    | 9    | 9                 | 9    | 9    | 9                  | 9    | 9                 | 9   |
|                  |      | MANÖVERSTÅNG           | 300 MM: 217 KR/ST |      |      | 600 MM: 217 KR/ST |      |      | 1200 MM: 306 KR/ST |      |                   |     |
|                  |      | PÅSLAG ALTERNATIV FÄRG | PRISGRUPP H1: 10% |      |      | PRISGRUPP H2: 15% |      |      | PRISGRUPP H3: 35%  |      | PRISGRUPP H4: 60% |     |

TILLVAL

Listan avser - Prisgrupp HE i kollektionen / Gavelbeslag och nedre fäste för lina ingår / Mått 10 mm över bredd & höjd kolumn debiteras efter närmast högre.

# INTU HONEYCELL

## DETALJERAD SPECIFIKATION

|                      |                                                      |
|----------------------|------------------------------------------------------|
| ANVÄNDNINGSSOMRÅDE   | Villor, radhus, kontor, butiker, skolor och sjukhus. |
| MÅTT ÖVERLIST        | 27,6 mm x 37,2 mm                                    |
| MÅTT UNDERLIST       | 20,2 mm x 28,7 mm                                    |
| MINSTA BREDD         | 220 mm                                               |
| MAX BREDD            | 1400 mm                                              |
| MINSTA HÖJD          | 100 mm                                               |
| MAX HÖJD             | 2500 mm                                              |
| MAX YTA              | 2,5 m <sup>2</sup>                                   |
| FÄRG PROFILER        | 27 färger (Lamell) / 1 färger (Över- & Underlist)    |
| FÄRG LINA & STEGBAND | 29 färger                                            |
| FÄRG DETALJER        | Vit                                                  |
| MONTERING            | På fönsterbågen eller karm                           |

|                  |                                                                                                                                                                                                                                  |
|------------------|----------------------------------------------------------------------------------------------------------------------------------------------------------------------------------------------------------------------------------|
| MONTERINGSBESLAG | Intubeslag                                                                                                                                                                                                                       |
| MATERIAL         | <ul style="list-style-type: none"> <li>- Över- &amp; Underlist: Aluminium</li> <li>- Väv: 100% polyester</li> <li>- Lina &amp; stegband: 100% polyester</li> <li>- Detaljer: Plast</li> <li>- Monteringsbeslag: Plast</li> </ul> |

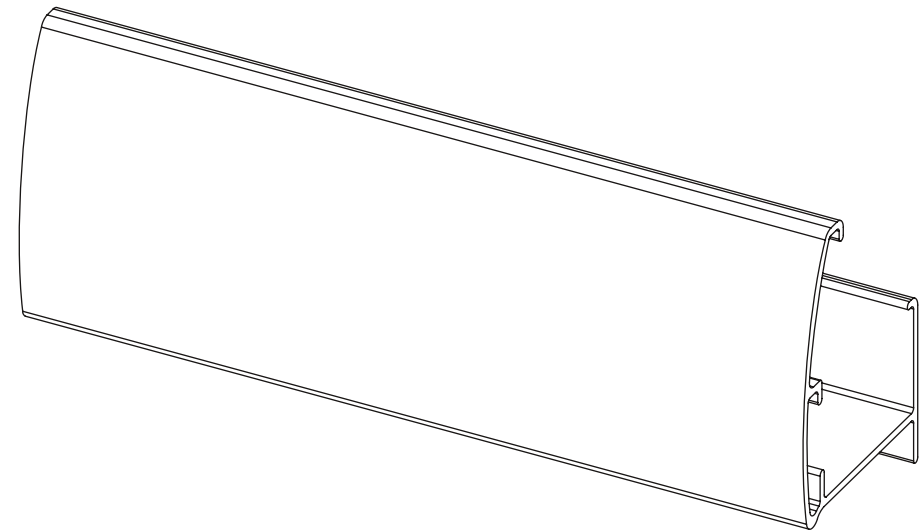
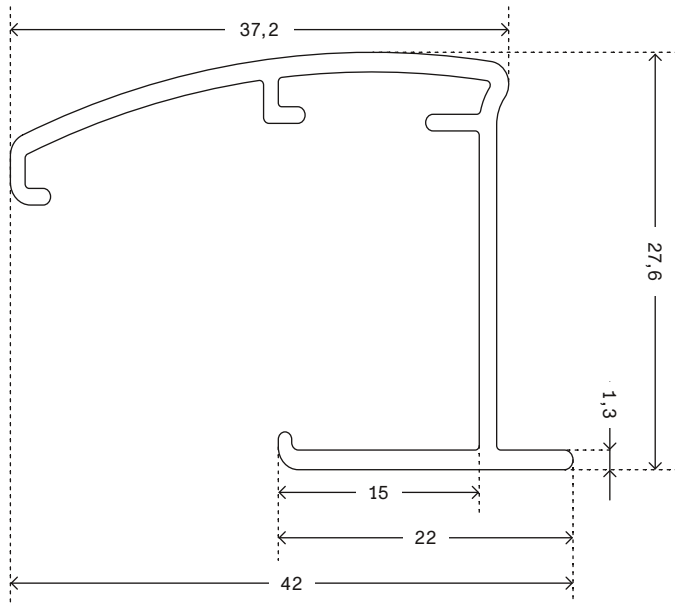

All rights reserved. This drawing is the property of Edsby-Persienner AB. The drawing may not be copied or multiplied in any way, neither wholly nor in part. It may not be submitted for perusal, or in any way shared with third parties without the written consent of Edsby-Persienner AB.

|                     |             |                           |                  |  |                           |              |
|---------------------|-------------|---------------------------|------------------|--|---------------------------|--------------|
| Designer<br>EP      | Drawn<br>EP | Approved                  | Weight<br>0.0 kg |  | Date<br>2024-04-01        | Replaces     |
|                     |             | Description<br>HEAD RAIL  |                  |  | Scale<br>2:1              | Sheet<br>1:1 |
| EDSBY-PERSIENNER AB |             | Article number<br>VIH201P |                  |  | Drawing number<br>VIH201P | Rev.<br>1    |

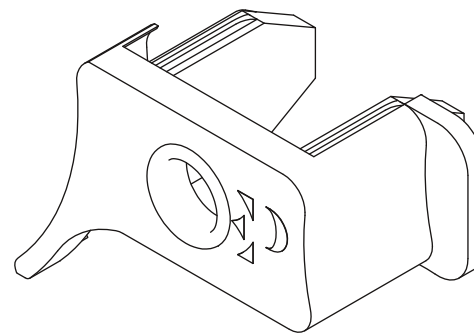
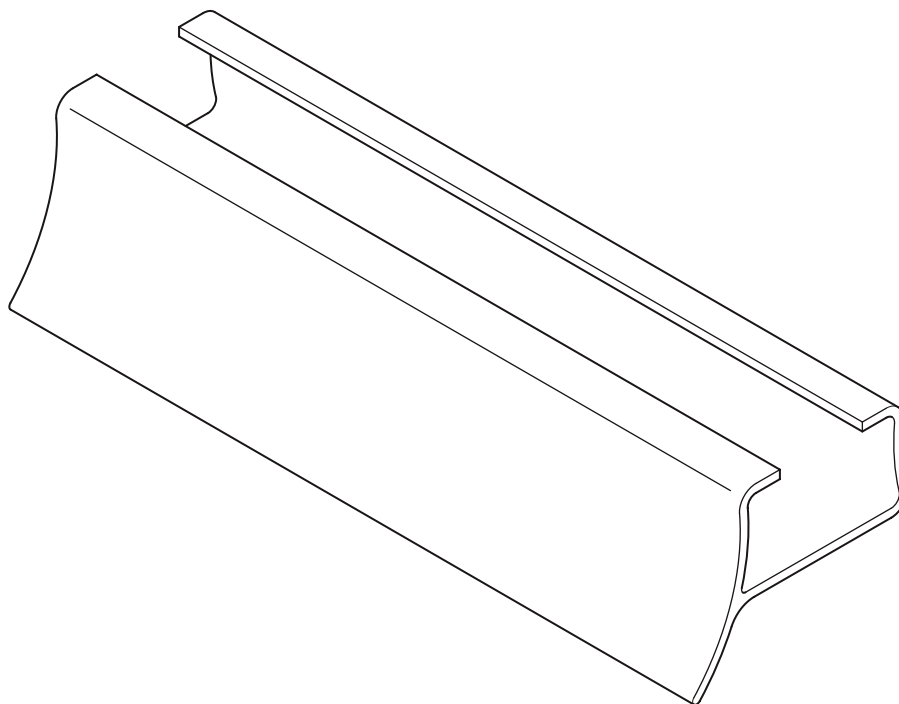
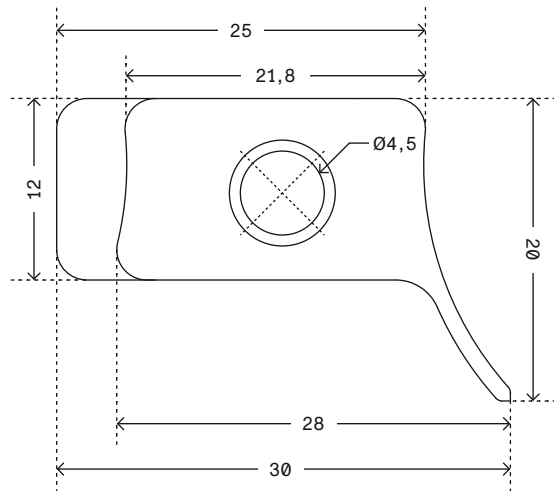
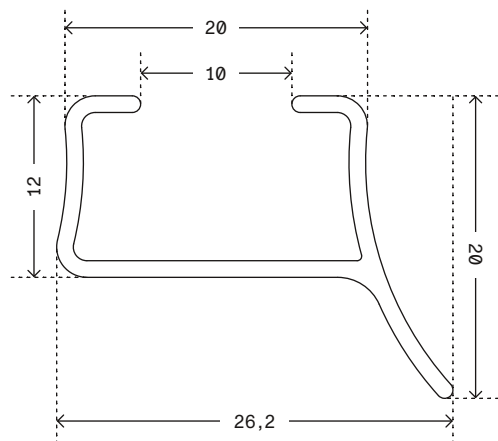

All rights reserved. This drawing is the property of Edsby-Persienner AB. The drawing may not be copied or multiplied in any way, neither wholly nor in part. It may not be submitted for perusal, or in any way shared with third parties without the written consent of Edsby-Persienner AB.

|                     |             |                                             |                  |  |                                 |              |
|---------------------|-------------|---------------------------------------------|------------------|--|---------------------------------|--------------|
| Designer<br>EP      | Drawn<br>EP | Approved                                    | Weight<br>0.0 kg |  | Date<br>2024-04-01              | Replaces     |
|                     |             | Description<br>BOTTOM RAIL/END CAP VENETIAN |                  |  | Scale<br>2:1                    | Sheet<br>1:1 |
| EDSBY-PERSIENNER AB |             | Article number<br>VIH205/VIH460             |                  |  | Drawing number<br>VIH205/VIH460 | Rev.<br>1    |

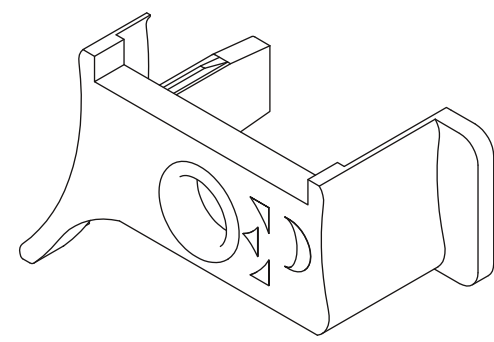
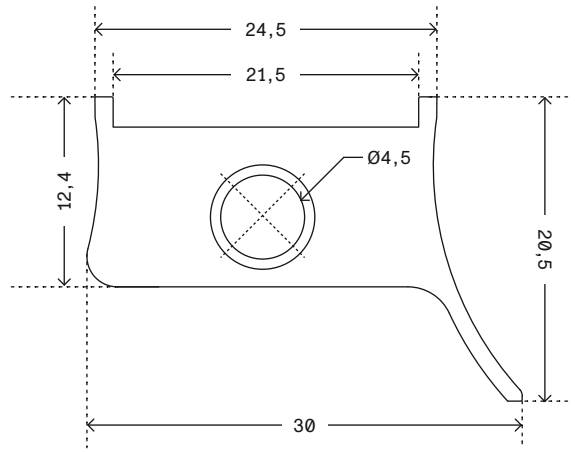
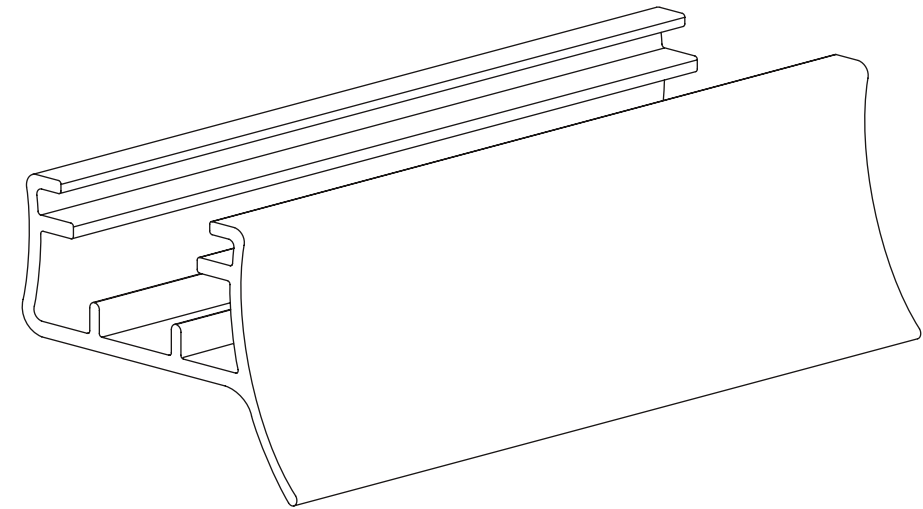
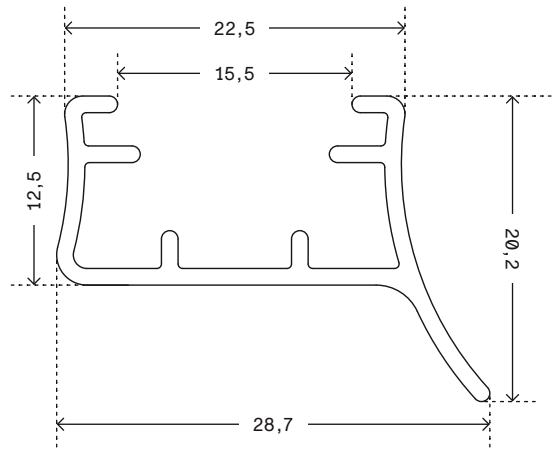

All rights reserved. This drawing is the property of Edsby-Persienner AB. The drawing may not be copied or multiplied in any way, neither wholly nor in part. It may not be submitted for perusal, or in any way shared with third parties without the written consent of Edsby-Persienner AB.

|                     |             |                                            |                  |  |                                 |              |
|---------------------|-------------|--------------------------------------------|------------------|--|---------------------------------|--------------|
| Designer<br>EP      | Drawn<br>EP | Approved                                   | Weight<br>0.0 kg |  | Date<br>2024-04-01              | Replaces     |
|                     |             | Description<br>BOTTOM RAIL/END CAP PLEATED |                  |  | Scale<br>2:1                    | Sheet<br>1:1 |
| EDSBY-PERSIENNER AB |             | Article number<br>VIH290/VIH461            |                  |  | Drawing number<br>VIH290/VIH461 | Rev.<br>1    |

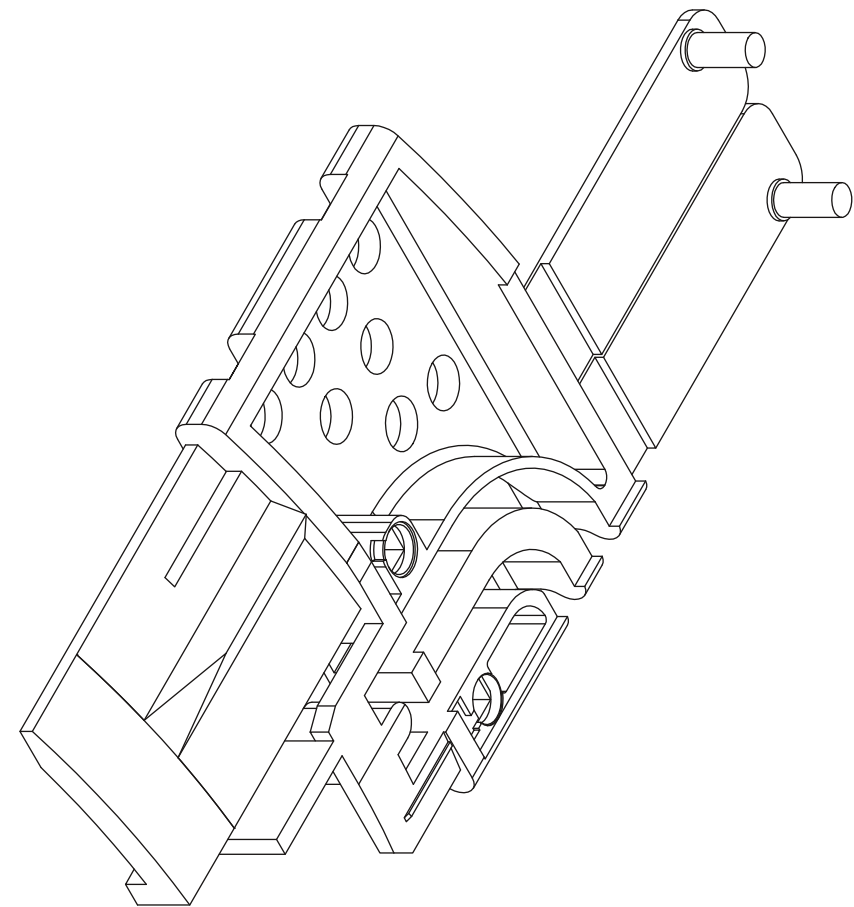
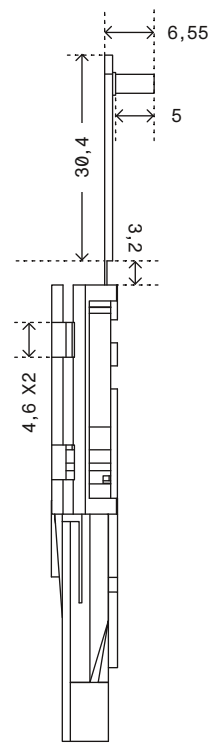
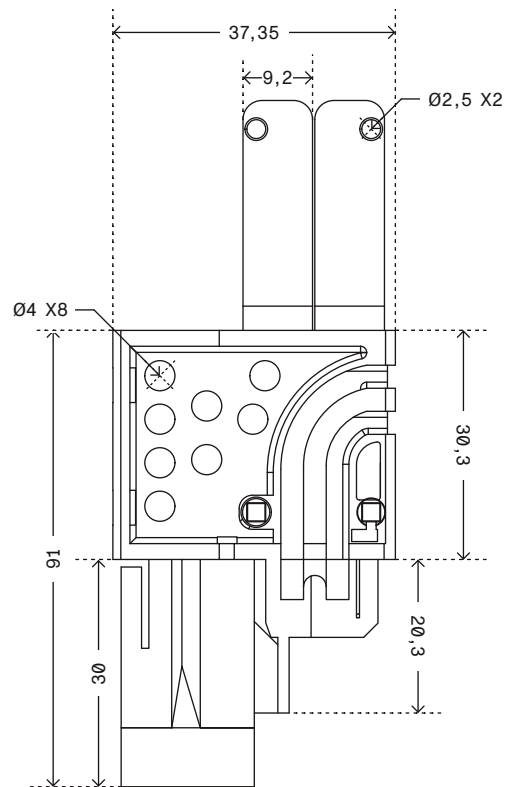

All rights reserved. This drawing is the property of Edsby-Persienner AB. The drawing may not be copied or multiplied in any way, neither wholly nor in part. It may not be submitted for perusal, or in any way shared with third parties without the written consent of Edsby-Persienner AB.

|                     |             |                            |                  |  |                          |              |
|---------------------|-------------|----------------------------|------------------|--|--------------------------|--------------|
| Designer<br>EP      | Drawn<br>EP | Approved                   | Weight<br>0.0 kg |  | Date<br>2024-04-01       | Replaces     |
|                     |             | Description<br>END CAP SET |                  |  | Scale<br>2:1             | Sheet<br>1:1 |
| EDSBY-PERSIENNER AB |             | Article number<br>VIH218   |                  |  | Drawing number<br>VIH218 | Rev.<br>1    |

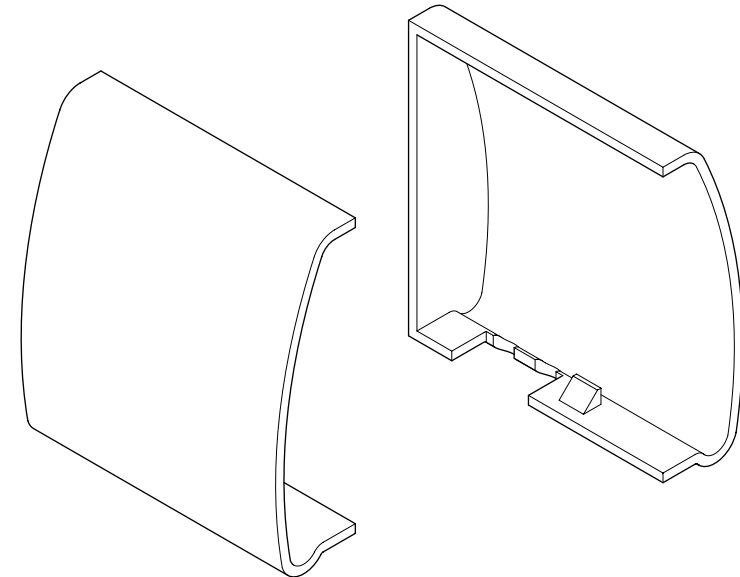
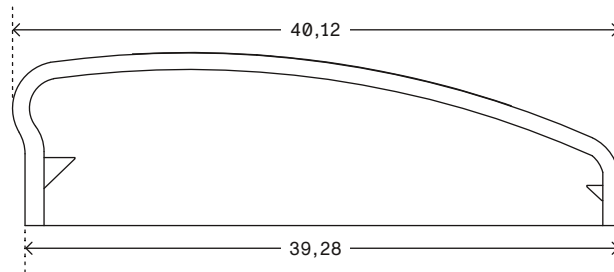
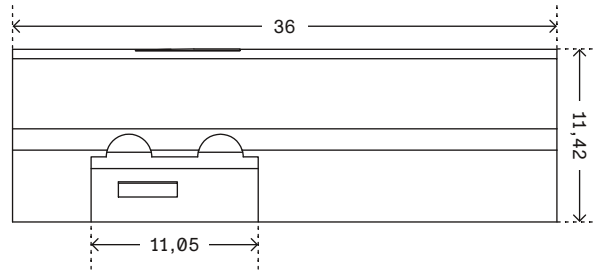

All rights reserved. This drawing is the property of Edsby-Persienner AB. The drawing may not be copied or multiplied in any way, neither wholly nor in part. It may not be submitted for perusal, or in any way shared with third parties without the written consent of Edsby-Persienner AB.

|                     |             |                                  |                  |  |                          |              |
|---------------------|-------------|----------------------------------|------------------|--|--------------------------|--------------|
| Designer<br>EP      | Drawn<br>EP | Approved                         | Weight<br>0.0 kg |  | Date<br>2024-04-01       | Replaces     |
|                     |             | Description<br>END CAP SET COVER |                  |  | Scale<br>2:1             | Sheet<br>1:1 |
| EDSBY-PERSIENNER AB |             | Article number<br>VIH222         |                  |  | Drawing number<br>VIH222 | Rev.<br>1    |

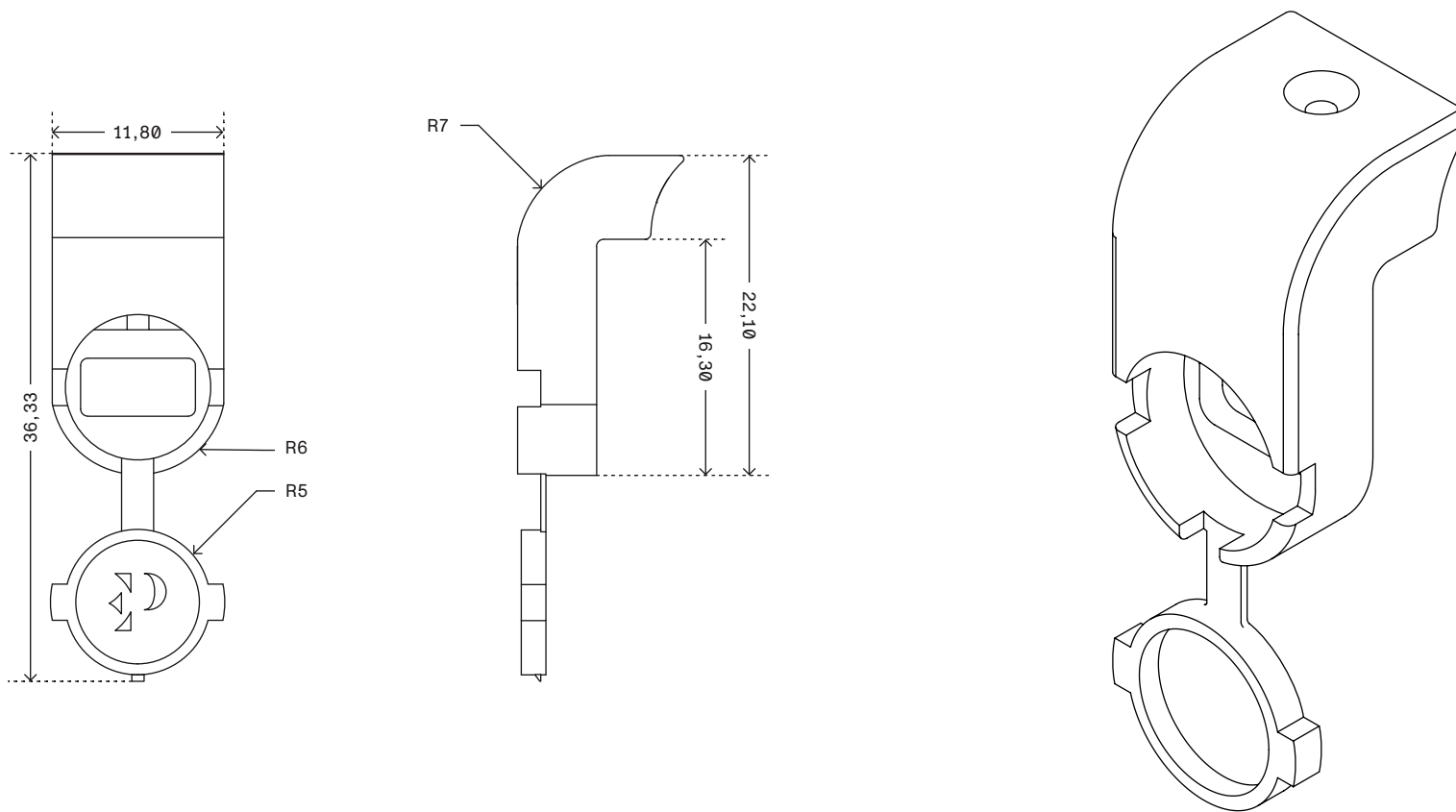

All rights reserved. This drawing is the property of Edsby-Persienner AB. The drawing may not be copied or multiplied in any way, neither wholly nor in part. It may not be submitted for perusal, or in any way shared with third parties without the written consent of Edsby-Persienner AB.

|                     |             |                                     |                  |  |                          |              |
|---------------------|-------------|-------------------------------------|------------------|--|--------------------------|--------------|
| Designer<br>EP      | Drawn<br>EP | Approved                            | Weight<br>0.0 kg |  | Date<br>2024-04-01       | Replaces     |
|                     |             | Description<br>CORD TENSION BRACKET |                  |  | Scale<br>2:1             | Sheet<br>1:1 |
| EDSBY-PERSIENNER AB |             | Article number<br>VIH338            |                  |  | Drawing number<br>VIH338 | Rev.<br>1    |

# DETALJER

## INTU

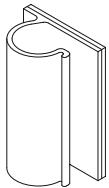

| Artikel                  | Pris / förpackning | Pris / styck |
|--------------------------|--------------------|--------------|
| VÄGGHÅLLARE MANÖVERSTÅNG | 120 KR             | 15 KR        |

| Artikelnummer | Färg | Förpackningsstorlek |
|---------------|------|---------------------|
| VIH275        | VIT  | 10 ST               |

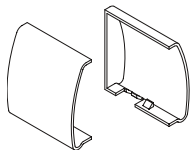

| Artikel  | Pris / förpackning | Pris / styck |
|----------|--------------------|--------------|
| ÄNDSKYDD | 1340 KR            | 18 KR        |

| Artikelnummer | Färg | Förpackningsstorlek |
|---------------|------|---------------------|
| VIH222        | VIT  | 100 ST              |

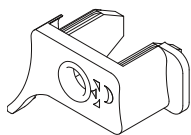

| Artikel                | Pris / förpackning | Pris / styck |
|------------------------|--------------------|--------------|
| ÄNDSKYDD UNDERLISTSATS | 1400 KR            | 19 KR        |

| Artikelnummer | Färg | Förpackningsstorlek |
|---------------|------|---------------------|
| VIH460        | VIT  | 100 ST              |

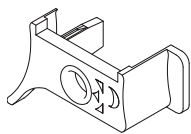

| Artikel                        | Pris / förpackning | Pris / styck |
|--------------------------------|--------------------|--------------|
| ÄNDSKYDD UNDERLISTSATS, PLISSÉ | 1360 KR            | 18 KR        |

| Artikelnummer | Färg | Förpackningsstorlek |
|---------------|------|---------------------|
| VIH461        | VIT  | 100 ST              |



# DETALJER

## INTU

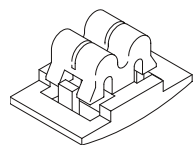

|                          |                    |              |
|--------------------------|--------------------|--------------|
| Artikel                  | Pris / förpackning | Pris / st    |
| <b>BOTTENLISTHÅLLARE</b> | <b>4250 KR</b>     | <b>11 KR</b> |

|               |            |                     |
|---------------|------------|---------------------|
| Artikelnummer | Färg       | Förpackningsstorlek |
| <b>VIH234</b> | <b>VIT</b> | <b>500 ST</b>       |

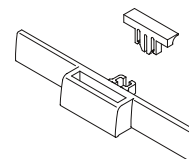

|                |                    |              |
|----------------|--------------------|--------------|
| Artikel        | Pris / förpackning | Pris / st    |
| <b>HANDTAG</b> | <b>5690 KR</b>     | <b>15 KR</b> |

|               |            |                     |
|---------------|------------|---------------------|
| Artikelnummer | Färg       | Förpackningsstorlek |
| <b>VIH238</b> | <b>VIT</b> | <b>500 ST</b>       |

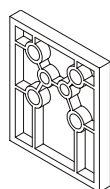

|                        |                    |             |
|------------------------|--------------------|-------------|
| Artikel                | Pris / förpackning | Pris / st   |
| <b>DISTANSÄNDSKYDD</b> | <b>3390 KR</b>     | <b>9 KR</b> |

|               |            |                     |
|---------------|------------|---------------------|
| Artikelnummer | Färg       | Förpackningsstorlek |
| <b>VIH226</b> | <b>VIT</b> | <b>500 ST</b>       |

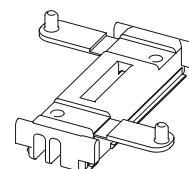

|                  |                    |              |
|------------------|--------------------|--------------|
| Artikel          | Pris / förpackning | Pris / st    |
| <b>LAGERBOCK</b> | <b>3700 KR</b>     | <b>10 KR</b> |

|               |            |                     |
|---------------|------------|---------------------|
| Artikelnummer | Färg       | Förpackningsstorlek |
| <b>VIH210</b> | <b>VIT</b> | <b>500 ST</b>       |

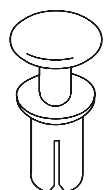

|                          |                    |             |
|--------------------------|--------------------|-------------|
| Artikel                  | Pris / förpackning | Pris / st   |
| <b>EXPANSIONSKLAMMER</b> | <b>540 KR</b>      | <b>4 KR</b> |

|               |            |                     |
|---------------|------------|---------------------|
| Artikelnummer | Färg       | Förpackningsstorlek |
| <b>PH018</b>  | <b>VIT</b> | <b>200 ST</b>       |

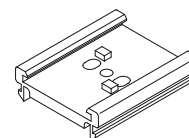

|                         |                    |             |
|-------------------------|--------------------|-------------|
| Artikel                 | Pris / förpackning | Pris / st   |
| <b>LAGERBOCK PLATTA</b> | <b>3160 KR</b>     | <b>9 KR</b> |

|               |            |                     |
|---------------|------------|---------------------|
| Artikelnummer | Färg       | Förpackningsstorlek |
| <b>VIH214</b> | <b>VIT</b> | <b>500 ST</b>       |

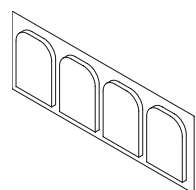

|                   |                    |             |
|-------------------|--------------------|-------------|
| Artikel           | Pris / förpackning | Pris / st   |
| <b>FÄSTPLATTA</b> | <b>3564 KR</b>     | <b>2 KR</b> |

|               |            |                     |
|---------------|------------|---------------------|
| Artikelnummer | Färg       | Förpackningsstorlek |
| <b>VIH048</b> | <b>VIT</b> | <b>3300 ST</b>      |

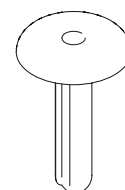

|                  |                    |             |
|------------------|--------------------|-------------|
| Artikel          | Pris / förpackning | Pris / st   |
| <b>FÄSTSTIFT</b> | <b>1680 KR</b>     | <b>5 KR</b> |

|               |            |                     |
|---------------|------------|---------------------|
| Artikelnummer | Färg       | Förpackningsstorlek |
| <b>VIH258</b> | <b>VIT</b> | <b>500 ST</b>       |

# DETALJER

## INTU

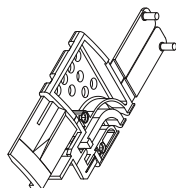

|                   |                    |              |
|-------------------|--------------------|--------------|
| Artikel           | Pris / förpackning | Pris / st    |
| <b>MANÖVERSET</b> | <b>2630 KR</b>     | <b>34 KR</b> |

|               |      |                     |
|---------------|------|---------------------|
| Artikelnummer | Färg | Förpackningsstorlek |
| VIH218        | VIT  | 100 ST              |

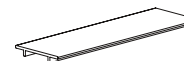

|                               |                    |              |
|-------------------------------|--------------------|--------------|
| Artikel                       | Pris / förpackning | Pris / st    |
| <b>MONTERINGSLIST, PLISSÉ</b> | <b>2039,76 KR</b>  | <b>37 KR</b> |

|               |      |                     |
|---------------|------|---------------------|
| Artikelnummer | Färg | Förpackningsstorlek |
| VIH295        | VIT  | 72 ST               |

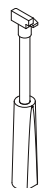

|                             |                    |               |
|-----------------------------|--------------------|---------------|
| Artikel                     | Pris / förpackning | Pris / st     |
| <b>MANÖVERSTÅNG 1200 MM</b> | <b>2380 KR</b>     | <b>306 KR</b> |

|               |      |                     |
|---------------|------|---------------------|
| Artikelnummer | Färg | Förpackningsstorlek |
| VIH270XL      | VIT  | 10 ST               |

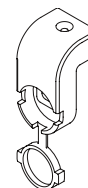

|                             |                    |             |
|-----------------------------|--------------------|-------------|
| Artikel                     | Pris / förpackning | Pris / st   |
| <b>NEDRE FÄSTE FÖR LINA</b> | <b>1210 KR</b>     | <b>4 KR</b> |

|               |      |                     |
|---------------|------|---------------------|
| Artikelnummer | Färg | Förpackningsstorlek |
| VIH338        | VIT  | 500 ST              |

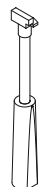

|                            |                    |               |
|----------------------------|--------------------|---------------|
| Artikel                    | Pris / förpackning | Pris / st     |
| <b>MANÖVERSTÅNG 300 MM</b> | <b>1690 KR</b>     | <b>217 KR</b> |

|               |      |                     |
|---------------|------|---------------------|
| Artikelnummer | Färg | Förpackningsstorlek |
| VIH270        | VIT  | 10 ST               |

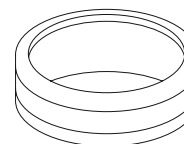

|             |                    |             |
|-------------|--------------------|-------------|
| Artikel     | Pris / förpackning | Pris / st   |
| <b>ÖGLA</b> | <b>460 KR</b>      | <b>2 KR</b> |

|               |         |                     |
|---------------|---------|---------------------|
| Artikelnummer | Färg    | Förpackningsstorlek |
| PH151         | MÄSSING | 500 ST              |

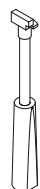

|                            |                    |               |
|----------------------------|--------------------|---------------|
| Artikel                    | Pris / förpackning | Pris / st     |
| <b>MANÖVERSTÅNG 600 MM</b> | <b>1690 KR</b>     | <b>217 KR</b> |

|               |      |                     |
|---------------|------|---------------------|
| Artikelnummer | Färg | Förpackningsstorlek |
| VIH270L       | VIT  | 10 ST               |



|                 |                    |               |
|-----------------|--------------------|---------------|
| Artikel         | Pris / förpackning | Pris / st     |
| <b>ÖVERLIST</b> | <b>7439,76 KR</b>  | <b>133 KR</b> |

|               |      |                     |
|---------------|------|---------------------|
| Artikelnummer | Färg | Förpackningsstorlek |
| VIH201P       | VIT  | 72 ST               |

# DETALJER

## INTU

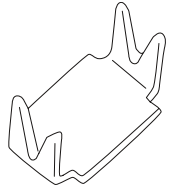

|                       |                    |             |
|-----------------------|--------------------|-------------|
| Artikel               | Pris / förpackning | Pris / st   |
| <b>SNÖRLÅSKLAMMER</b> | <b>7500 KR</b>     | <b>1 KR</b> |

|               |              |                     |
|---------------|--------------|---------------------|
| Artikelnummer | Färg         | Förpackningsstorlek |
| <b>VH613</b>  | <b>METAL</b> | <b>10000 ST</b>     |

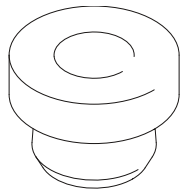

|                       |                    |              |
|-----------------------|--------------------|--------------|
| Artikel               | Pris / förpackning | Pris / st    |
| <b>SNÖRLÅSKLAMMER</b> | <b>3510 KR</b>     | <b>10 KR</b> |

|               |              |                     |
|---------------|--------------|---------------------|
| Artikelnummer | Färg         | Förpackningsstorlek |
| <b>VIH296</b> | <b>METAL</b> | <b>500 ST</b>       |

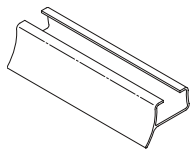

|                  |                    |               |
|------------------|--------------------|---------------|
| Artikel          | Pris / förpackning | Pris / st     |
| <b>UNDERLIST</b> | <b>7899,84 KR</b>  | <b>142 KR</b> |

|               |            |                     |
|---------------|------------|---------------------|
| Artikelnummer | Färg       | Förpackningsstorlek |
| <b>VIH205</b> | <b>VIT</b> | <b>72 ST</b>        |

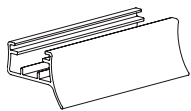

|                         |                    |               |
|-------------------------|--------------------|---------------|
| Artikel                 | Pris / förpackning | Pris / st     |
| <b>UNDERLIST PLISSÉ</b> | <b>5549,76 KR</b>  | <b>100 KR</b> |

|               |            |                     |
|---------------|------------|---------------------|
| Artikelnummer | Färg       | Förpackningsstorlek |
| <b>VIH290</b> | <b>VIT</b> | <b>72 ST</b>        |

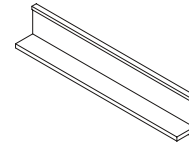

|                 |                    |              |
|-----------------|--------------------|--------------|
| Artikel         | Pris / förpackning | Pris / st    |
| <b>VRIDLIST</b> | <b>6919,2 KR</b>   | <b>38 KR</b> |

|               |            |                     |
|---------------|------------|---------------------|
| Artikelnummer | Färg       | Förpackningsstorlek |
| <b>VIH209</b> | <b>VIT</b> | <b>240 ST</b>       |



BESÖKSADRESS

Karlsvägen 10  
828 32 Edsbyn

TELEFON

+46 271 181 13

EPOST

[info@edsbypersienner.se](mailto:info@edsbypersienner.se)

2024.04.01

Vi reserverar oss för eventuella  
tryckfel gällande priser och  
produkter.